

IN-16 NIXIE TUBE CLOCK KIT

Assembly instruction and user manual

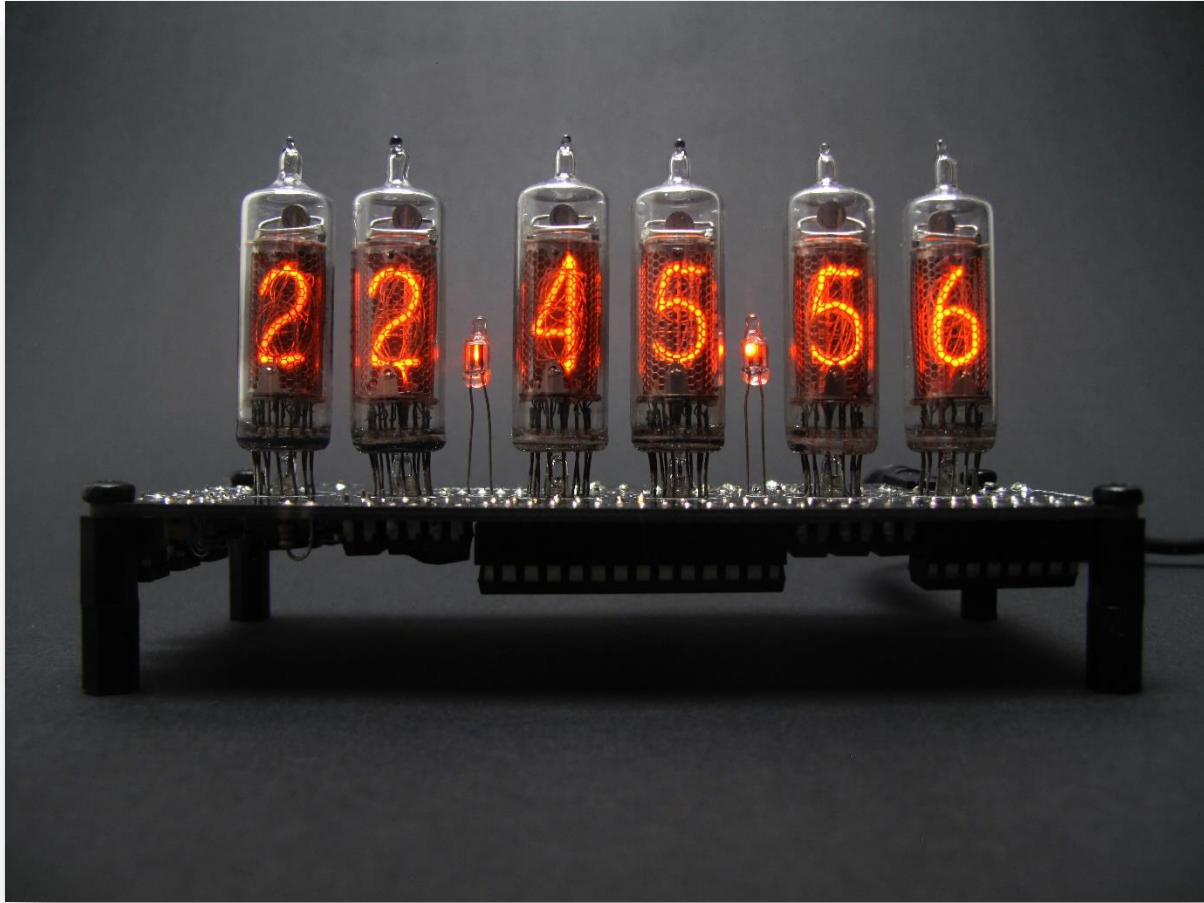

Bring to your home a piece of history with The Vintage Nixie Clock and its Cold War era components. The clock will give a cosiness and a uniqueness for your house. To warm clock digits shine you want to see permanently as to flame of fire.

Introduction

This parts kit intended for an electronics hobbyists that want to make a Nixie clock and do not want go deep to complicated clock control electronics and software. This instruction step-by-step assists you to assemble the clock.

The kit consists all necessary electronics parts (excluding Nixie tubes and power adapter) and a microcontroller with pre-programmed an application software.

The main features of the clock

- Hours, Minutes and Seconds display
- 12 or 24 hour operation modes
- Time accuracy is provided by built-in RTC (Real Time Clock) based on extremely precise DS3231 module with temperature compensation and backup with CR2032 battery
- Programmable leading zero blanking
- Date display in either DD/MM/YY or MM/DD/YY format
- Alarm
- Simple time setting using three buttons
- Standard, crossfade and scrollback display modes
- "Slot Machine" Cathode poisoning prevention routine
- Programmable Blue LED tube lighting
- Not AC frequency dependent – works in all countries
- Auto increase of adjusting value for quick time setting
- Neon colon indicators blinking at 1 Hz
- Tubes are driven in high frequency dynamical indication and provide service for many years

Safety precautions

The clock printed circuit board (PCB) includes a High Voltage source that powers the Nixie tubes. Its output voltage can reach 180 Volts DC. The voltage generated by this source can give a potentially LETHAL ELECTRIC SHOCK. When PCB is powered its contacts shall be not touched by hands or non-isolated tools (non-isolated tweezers for example).

Required experience

This product is supplied as a kit of parts, intended only for suitably qualified electronic hobbyists, who are suitably qualified and experienced in electronics assembly and electronics components proper soldering, and are familiar with safe procedures for working with high voltage and its potentially danger.

Assembly and testing of the clock from this kit should be attempted by competent persons only, or under supervision of someone fully experienced in this field.

Correct component placement is critical. A few minutes spent checking placement and orientation prior to soldering will save hours of mistakes search and rework later.

REMEMBER: A properly placed components and carefully soldered PC board will perform well for years, a hastily assembled board will cause ongoing clock problems and failures.

The most important skill for our kit assembly is an electronic components soldering. If you have not an experience enough, next site with Basic Soldering Guide will be useful for you:

<https://learn.sparkfun.com/tutorials/how-to-solder-through-hole-soldering>

Tools and materials required for assembly

- Screwdriver
- Angled tweezers with thin noses
- Long nose pliers for tube leads bonding
- Side cutting pliers to trim the excess component leads after soldering
- Electronics grade solder 0.5-1mm thickness that contains cores of "flux" which helps the molten solder to flow more easily over the joint
- De-soldering wick or pump may be useful if you accidentally create solder bridges between adjacent solder joints or improper solder any component
- Soldering iron with small a "tinned" tip
- Multi-meter for voltage measurements and for identifying the resistors
- Magnifying glass.



The clock kit does not include next components

- A power adapter. Output voltage 12V DC, output current ~1A. Output end plug – 5.5 x 2.1mm, centre positive. It is cheaper to buy such power adapter in your local electronics shop because it will be equipped by necessary grid plug. You may have similar power adapter in your house also because such type power adapters are popular and widely use.

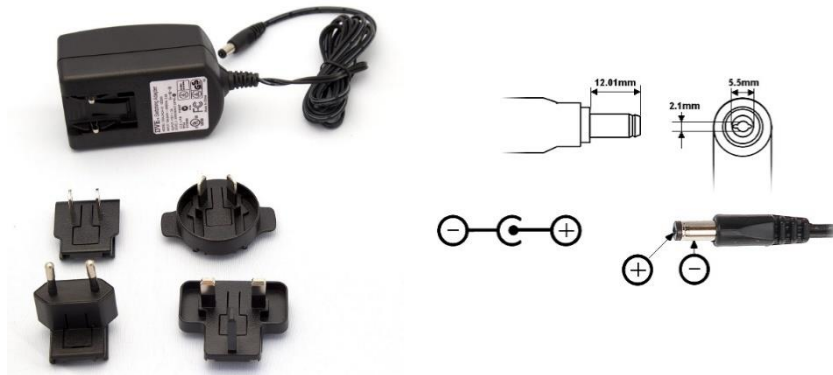

- 6 pcs Nixie tubes. The kit consists electronics components necessary for a clock assembly only. Nixie tubes need to purchase separately.



Parts list

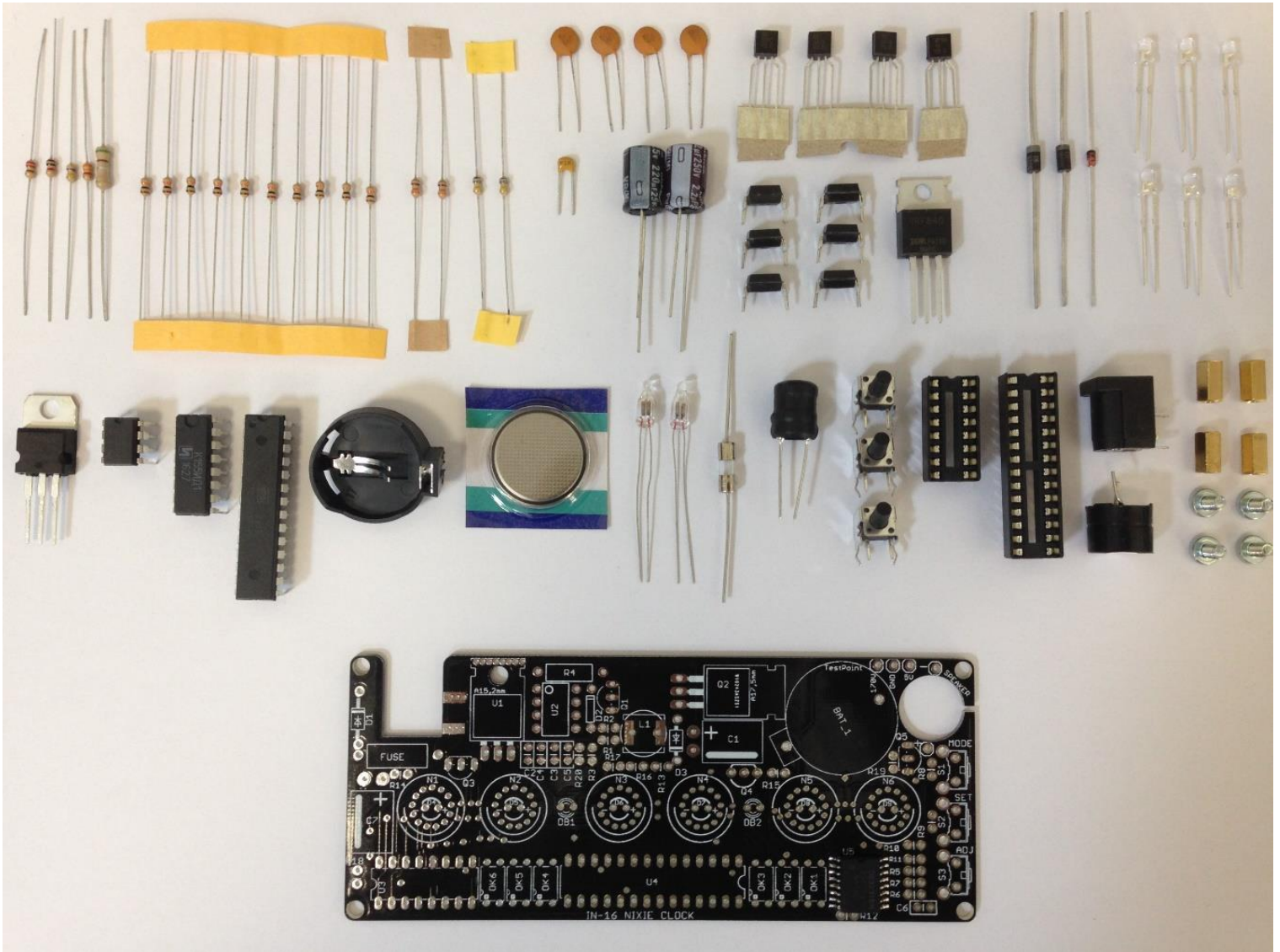

Component designation	Component description
RESISTORS	
R1	470k Ω , 0.25W
R2	1k Ω , 0.25W
R3	3.3k Ω , 0.25W
R4	0.51 Ω , 0.5W
R5, R6, R7, R8, R9, R10, R11, R15, R18, R19	10k Ω , 0.25W
R20	220 Ω , 0.25W
R12, R14	330 Ω , 0.25W
R16, R17	680k Ω , 0.25W

CAPACITORS	
C1	2.2uF, 250V, Electrolytic
C2, C3, C5, C6	0.1uF, Ceramic
C4	2.2nF, Ceramic
C7	220uF, 25V, Electrolytic
TRANSISTORS	
Q1	BC557
Q2	IRF840, MOSFET
Q3, Q5	BC547
Q4	MPSA42
OK1-OK6	EL817, Optocoupler
DIODES	
D1	1N4004
D2	1N914
D3	UF4004
D4-D9	LED, 3mm
INTEGRATED CIRCUITS	
U1	LM7805
U2	MC34063
U3	K155ID1
U4	ATMEGA328P-PU
U5	DS3231
MISCELLANEOUS	
PCB	Nixie Clock PCB
BAT_1	CR2032 Battery socket
Battery	3V CR2032
DB1, DB2	Neon bulb
FUSE	0.5A
L1	330uH, 1A Inductor
N1 - N6	IN-16 Nixie tube
S1 - S3	Buttons
U3 Socket	16pin socket
U4 Socket	28pin socket
Power socket	5.5mm x 2.1mm
Speaker	Active alarm buzzer
PCB Spacers (10mm)	4 PCB spacers
Screws	4 Screws 3mm

NOTES:

- Components actual view can differ due to different manufacturers.
- If an inscription or color bar coding of the component is small, it is necessary to use the magnifying glass.

Components review
Resistors

1k Ω (R2)



10k Ω (R5, R6, R7, R8, R9,
R10, R11, R15, R18, R19)



470k Ω (R1)



0.51 Ω (R4)

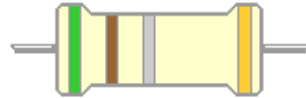

3.3k Ω (R3)



330 Ω (R12, R14)



680k Ω (R16, R17)

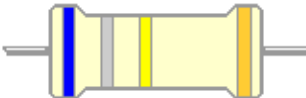

220 Ω (R20)



The resistors used in the kit are marked with four coloured bands to identify the value. Bands 1 and 2 identify the first two digits, band 3 is the Multiplier and band 4 is the tolerance.

The first, second and third coloured bands on the resistors indicate the resistance using a colour code. This table indicates how to convert each colour to its numerical equivalent. Gold band means 5% tolerance.

Band colour	Numerical equivalent	Band colour	Numerical equivalent
black	0	green	5
brown	1	blue	6
red	2	violet	7
orange	3	grey	8
yellow	4	white	9

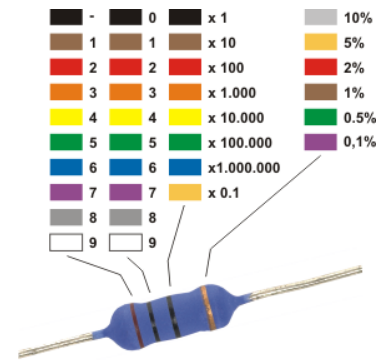

To read a resistor code, first locate the gold band and read the colours in order from the other end. (All resistors in this kit have a gold band indicating 5% tolerance.) The first two bands indicate digits in the resistance; the third band (called the multiplier) indicates the number of zeroes to be added to the digits to obtain the resistance. However, it is sometimes unclear in which direction the bands should be read. Therefore, we recommend that the resistors will be identified with a multimeter. Use the resistor code to identify and sort all of the resistors. One good way to keep them sorted is to tape one end to a piece of paper and write the resistance and component number (R1, R2, etc.). Once you have identified and sorted all of the resistors, you are ready to solder them to the PCB. To prepare a resistor for insertion into the board, bend the two leads so that they form a right angle to the resistor body.

Capacitors

0.1uF (Code 104), (C2, C3, C5, C6)



2.2nF (Code 222), (C4)



220uF 25V, (C7)



2.2uF 250V, (C1)



Transistors

BC547, (Q3, Q5)

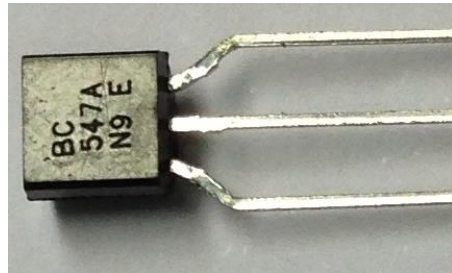

BC557, (Q1)

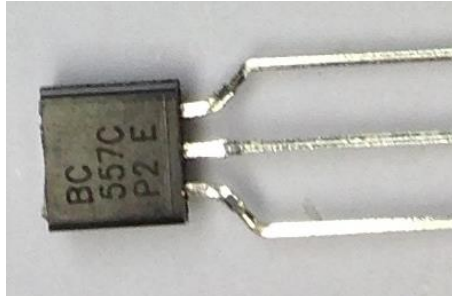

MPSA42, (Q4)

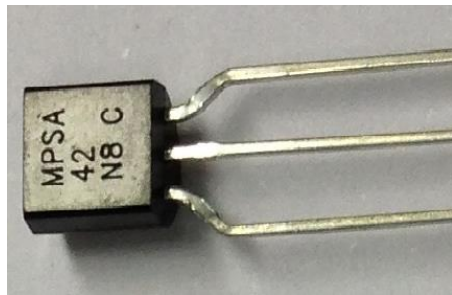

IRF840, MOSFET, (Q2)

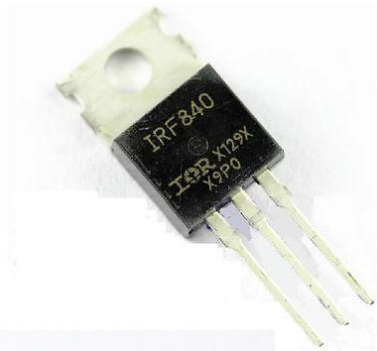

EL817, (OK1-OK6)

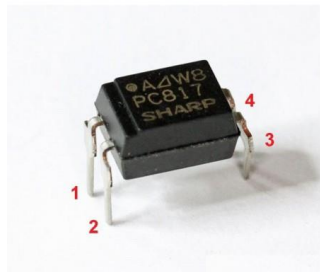

Diodes

1N4004 (D1)



UF4004 (D3)

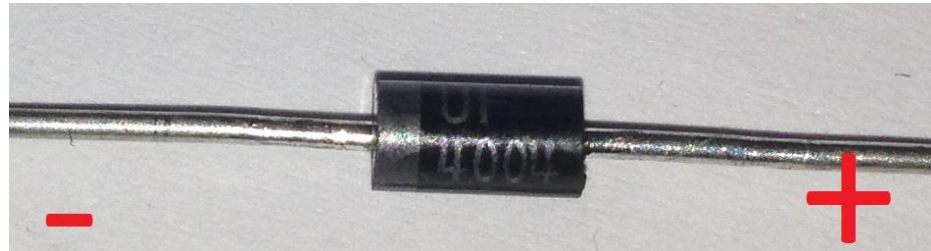

1N914 (D2)

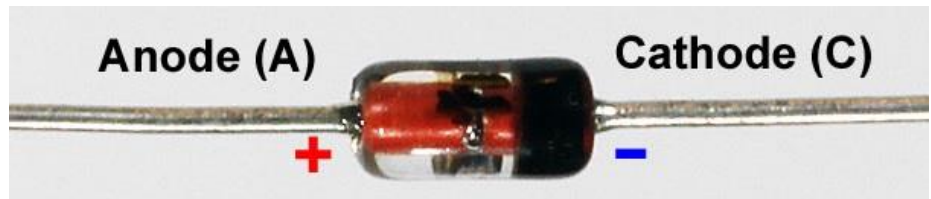

LED, 3mm (D4-D9)

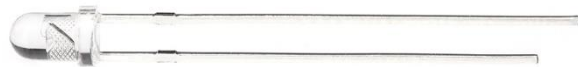

Integrated Circuits

LM7805 (U1)

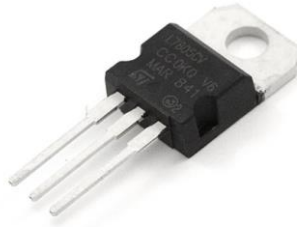

MC34063 (U2)



K155ИД1 (U3)



ATMEGA328P-PU (U4)

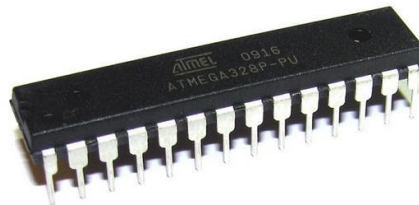

DS3231 (U5)



Miscellaneous

CR2032 Battery socket (BAT_1)



Battery



Neon bulb (DB1, DB2)



Fuse



330uH, 1A Inductor (L1)



Button (S1-S3)



16 pin socket

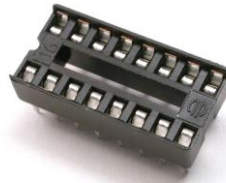

28 pin socket



Power socket (5.5mm x 2.1mm)



Speaker



PCB Spacers



3mm screw



Packing Sheet

Component description	Quantity, pcs
RESISTORS	
1k Ω , 0.25W	1
470k Ω , 0.25W	1
3.3k Ω , 0.25W	1
0.5 Ω , 0.5W	1
10k Ω , 0.25W	10
330 Ω , 0.25W	2
680k Ω , 0.25W	2
220 Ω , 0.25W	1
CAPACITORS	
2.2 μ F, 250V, Electrolytic	1
220 μ F, 25V, Electrolytic	1
0.1 μ F, Ceramic	4
2.2nF, Ceramic	1
TRANSISTORS	
BC557	1
IRF840, MOSFET	1
BC547	2
MPSA42	1
EL817, Optocoupler	6
DIODES	
1N4004	1
1N914	1
UF4004	1
LED, 3mm	6
INTEGRATED CIRCUITS	
LM7805	1
MC34063	1
K155ID1	1
ATMEGA328P-PU	1
DS3231	1
MISCELLANEOUS	
Nixie Clock PCB	1
CR2032 Battery socket	1
CR2032 Battery	1
Neon bulb	2
330 μ H, 1A Inductor	1
Buttons	3
16 pin socket	1
28 pin socket	1
Power socket (5.5mm x 2.1mm)	1
Speaker	1
PCB spacers (10mm)	4
Screws	4
Fuse	1

PCB assembly sequence

NOTES:

- This instruction contents high definition pictures. If anywhere is uncertainty, PCB view can magnify and an interested component may to view in details.
- The side of the board that has printed component marking is the “component side”. This means that components must mount by inserting them down from the printed side. Make sure that the components mount on the proper side of the PCB!
- Prior to beginning an assembly, make sure to have a well-lighted, well-ventilated workplace. Make sure that all of the electronic assembly tools are available.

1. Screwing PCB spacers to PCB by screws

Spacers lift the PCB over table surface. It will be more convenient to install and to solder components to the PCB. These spacers can use for fixing an assembled clock in applicable casing also.

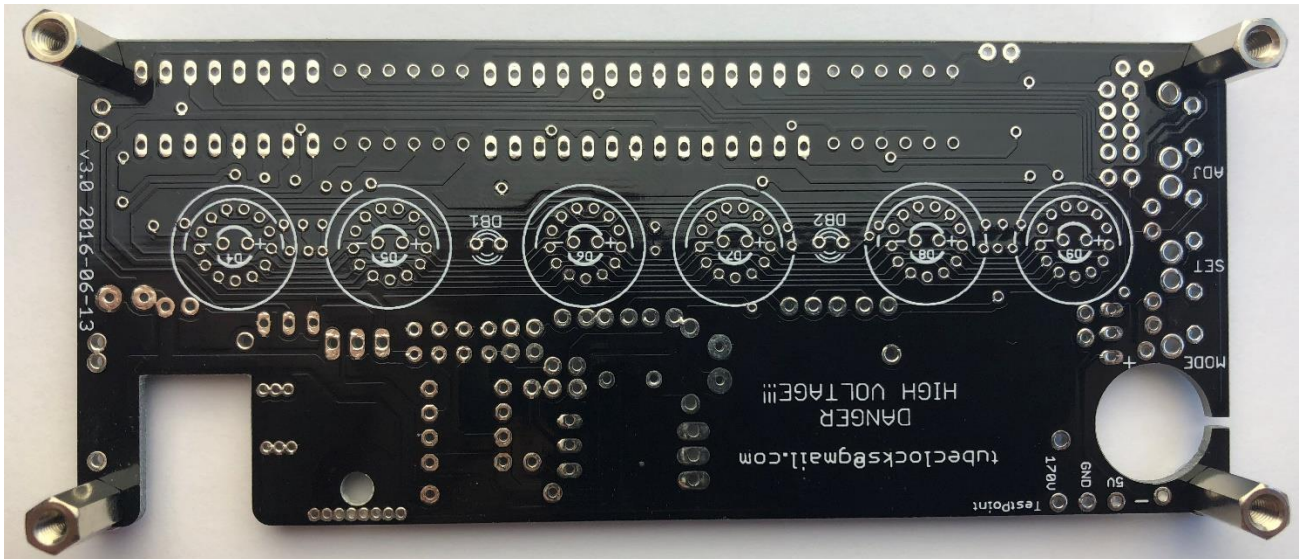

2. Low Voltage Power source components preparation for insertion into the board and soldering order

U1	LM7805
C7	220uF, 25V, Electrolytic
C2	0.1uF, Ceramic
D1	1N4004
FUSE	FUSE 0.5A
Power socket	5.5mm x 2.1mm PCB DC Jack

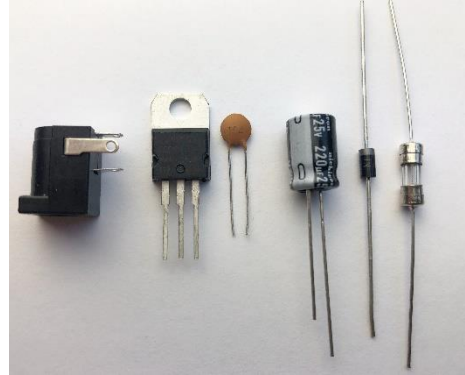

2.1. Cut side contact of the power receptacle.



2.2. Bend U1 integrated circuit leads.



2.3. Bend the two leads of the C7 capacitor so that they form a right angle to the capacitor body.



2.4. Bend the two leads of the fuse and diode D1 so that they form a right angle to the component body.

2.5. To install, place the leads of the component through the appropriate holes and press the component down against the component side of the PCB.

2.5.1. The small-value ceramic capacitor (C2) may be installed in either orientation, but the larger-value cylindrical capacitor (C7) must be installed with the proper polarity. The polarity is indicated on the PCB by a "+" sign near one end of the capacitor location. The polarity is indicated on the body of the capacitor with a stripe with a minus (-) sign located on the negative side of the capacitor. In addition, the shorter lead is the negative lead.

2.5.2. Either lead of the fuse may be inserted in either hole its location.

2.5.3. Turn the board over while holding the relevant component in position and bend the leads slightly outward to hold the component in place. Solder the leads to the contact and trim the excess lead wire above the solder joint.

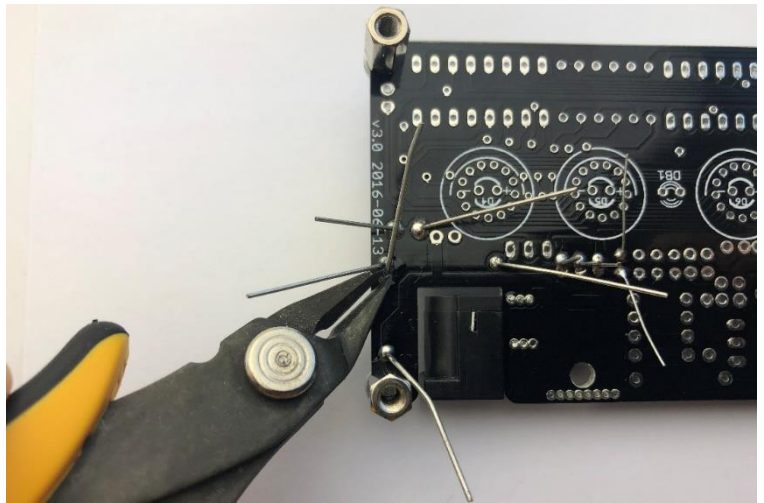
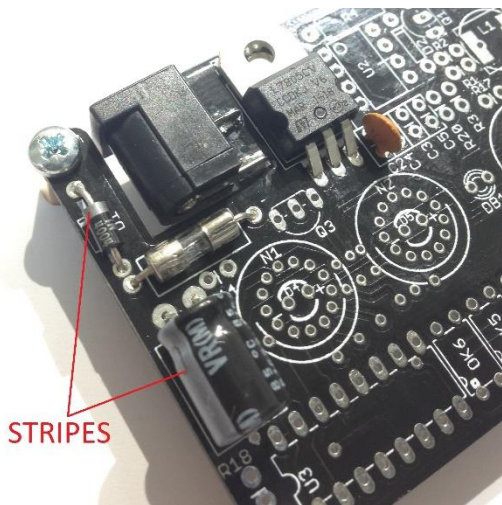
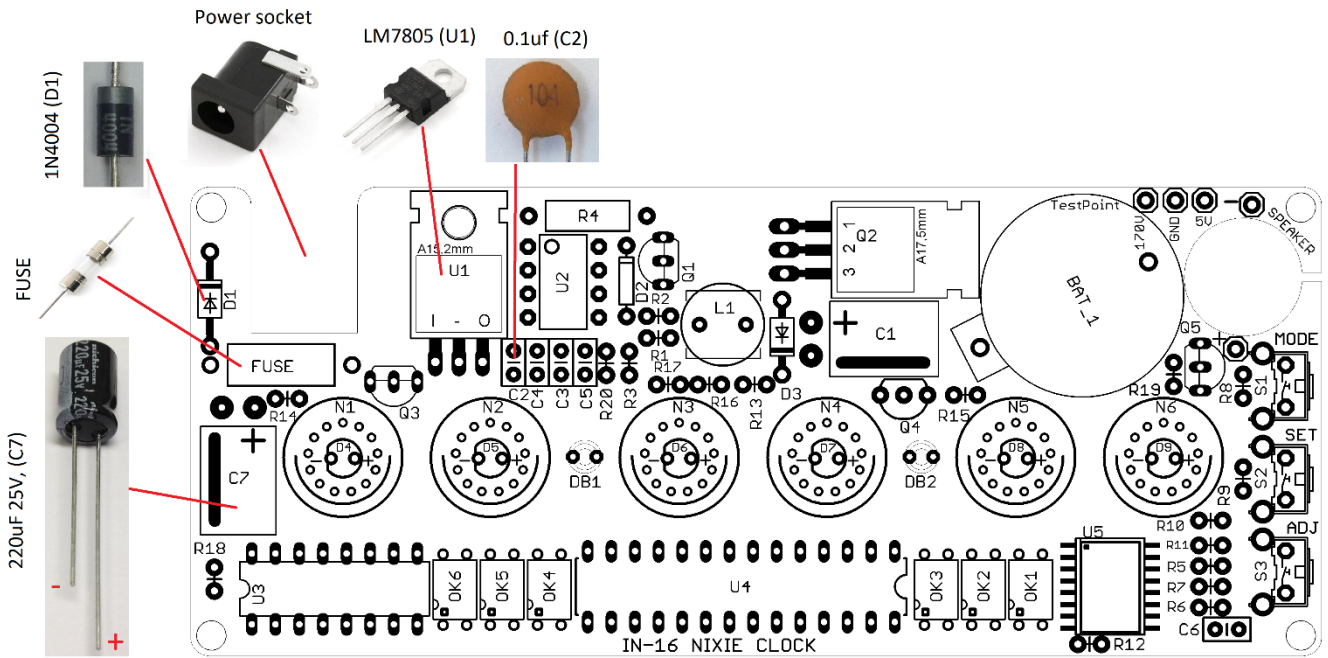

NOTES:

- To make sure that capacitor C7 and diode D1 polarity is not mistaken.
- To make sure that integrated circuit U1 (LM7805) is not mistaken with transistor Q2 (IRF840) and diode D1 (1N4004) is not mistaken with diode D3 (UF4004) because they look like similar.

3. High voltage generator components preparation for insertion into the board and soldering order

U2	MC34063
Q1	BC557
Q2	IRF840
D3	UF4004
D2	1N914
L1	Inductor 330uH
C1	2.2uF, 250V
C3, C5	0.1uF
C4	2.2nF
R4	0.5Ω 0.5W
R2	1kΩ
R3	3.3kΩ
R20	220Ω
R1	470kΩ

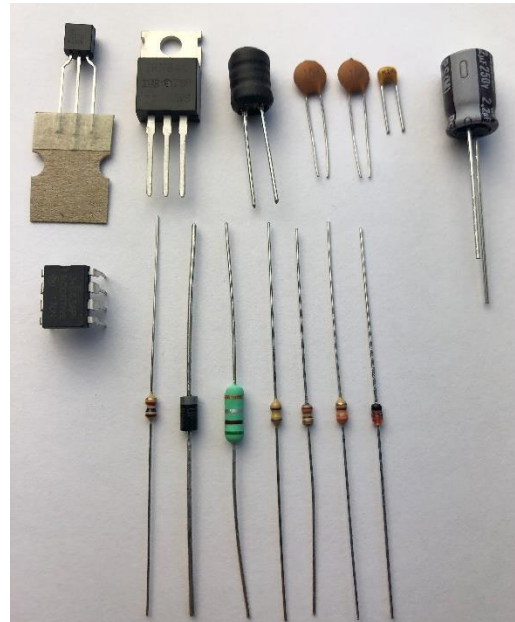

3.1. All resistors (except R4) leads bend in accordance with this picture that each resistor place on board surface will be minimal.



3.2. By using long nose pliers, bend inductor L1 leads. Bending the leads directly near casing may discontinue this inductor coil wires that are soldered to leads.



3.3. Bend the capacitor C1 leads.



3.4. Repeat actions pointed in items 2.5, 2.5.1 and 2.5.3 for proper components insertion into the PCB and soldering.

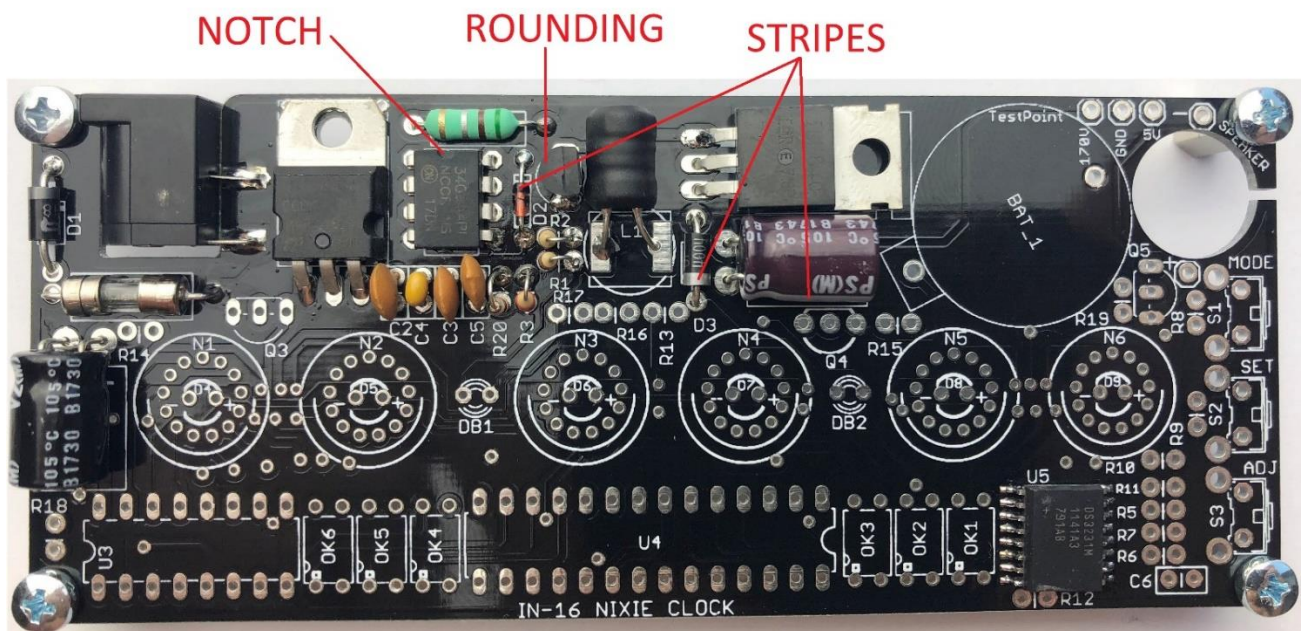
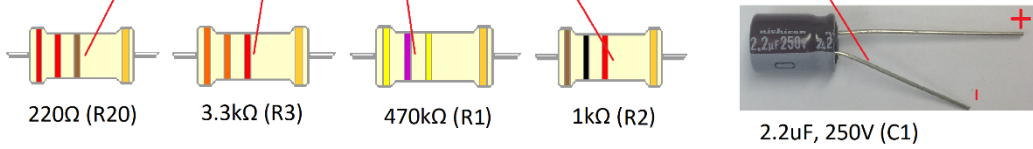
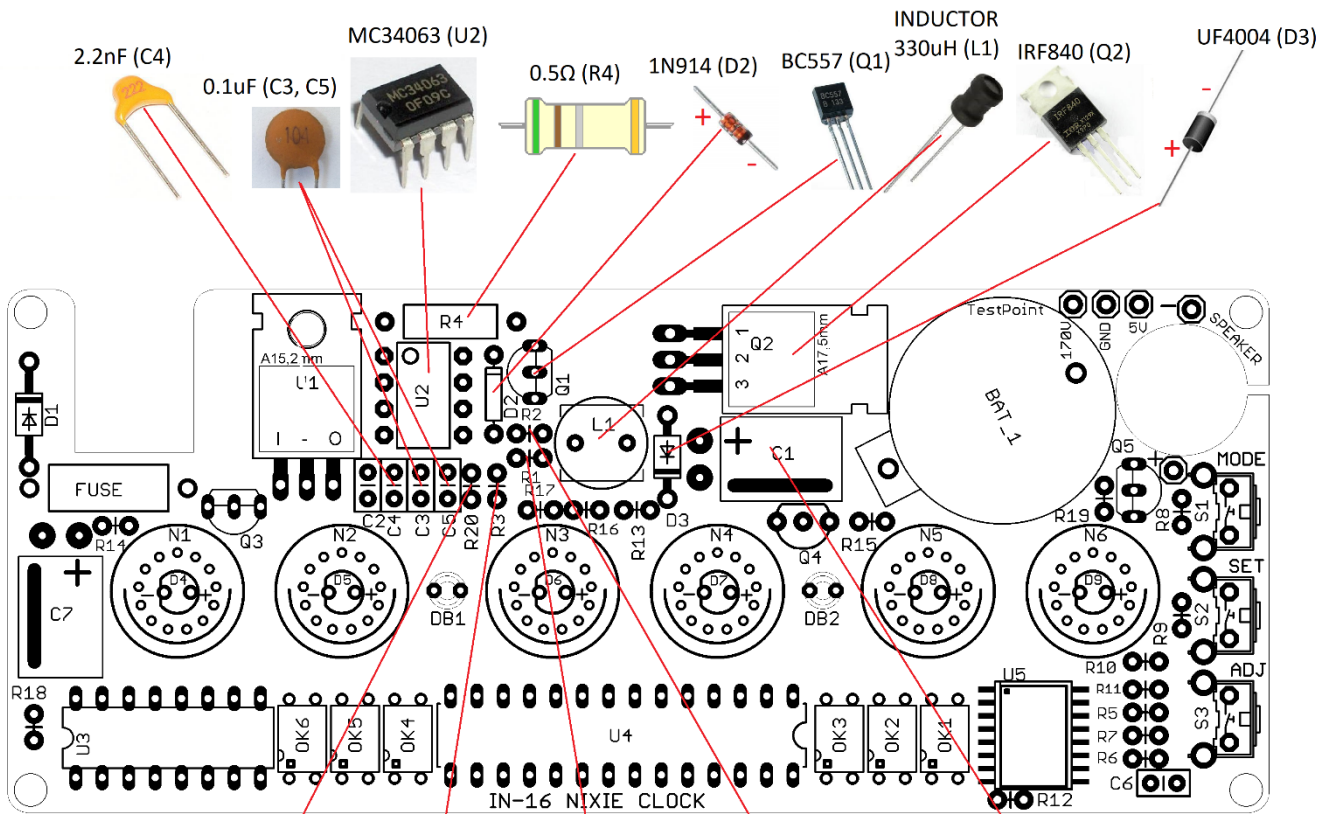

3.5. Bend the resistor contact and solder into place R13.

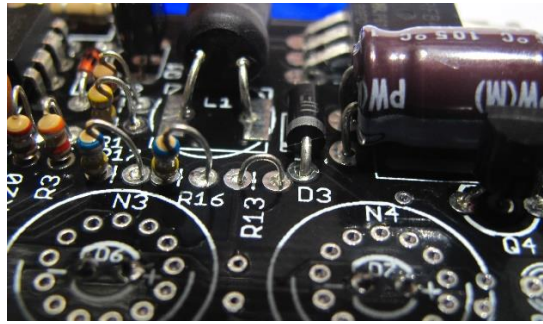
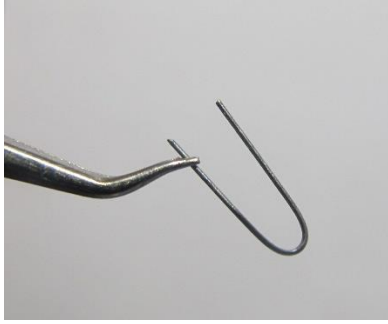

4. Low and High Voltage sources operability test

After Low and High Voltage sources components assembly it is necessary to check relevant source proper operability.

4.1. Select multi-meter DC 200 V measuring range.



4.2. Identify the test ground (GND), 5V and HV test points as shown below.

4.3. Plug in the power supply, and then test HV source operability using a multi-meter in DC voltmeter mode. Touch the black probe on the GND test point and the red probe on the 170 V test point. The voltage should measure between 160 and 175 Volts. When PCB is powered its HV source contacts shall be not touched by hands or non-isolated tools (non-isolated tweezers for example). If not, disconnect power and remember that the HV source output could still hold charge at 165-175 V. Check all relevant joints quality and polarity.

Do not continue with the next test until the error in HV source exists.

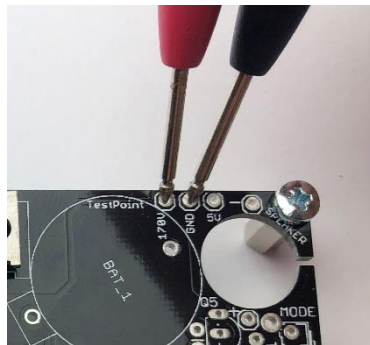
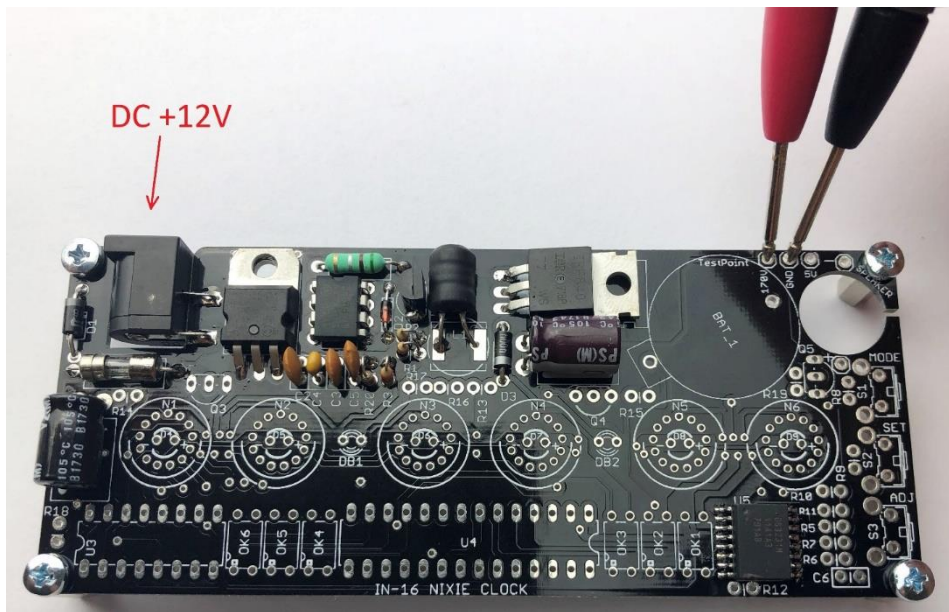

4.4. Test low voltage (LV) source operability. Touch the black probe on the GND test point and the red probe on the 5V test point. The voltage should measure between 4.8 and 5.2 Volts. If not, disconnect power and check all relevant joints quality and polarity. Do not continue with the assembly until the error will be corrected.

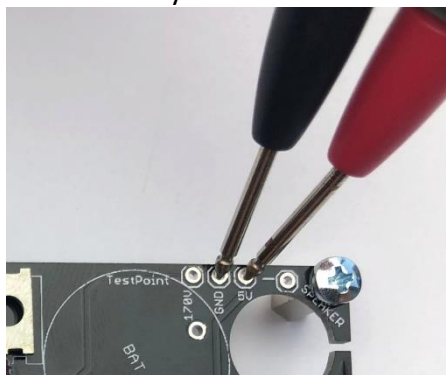

4.5. Once the last test of LV source is completed, disconnect the power.

5. Microcontroller circuit components assembly

U4	Atmega328P-PU
R11	10kΩ
U4 Socket	28 pin socket

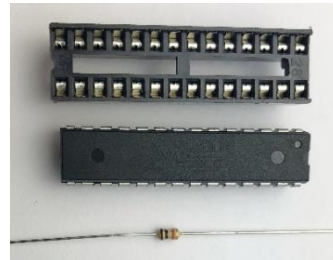

NOTES:

- Do not place the microcontroller U4 into the socket before you mount the socket onto the board.
- Mount the socket such that the notch in the socket lines up with the notch marking in rectangular outline printed on the board.
- After inserting a socket into the board, solder its two opposite-corners pins first. This will hold the socket in place. Look at it carefully to check its proper orientation. If not, it is easy to heat one or both pins and adjust the socket. Only if everything is correct, solder the rest of the pins. Remember: to keep the soldering time per pin brief. The pins do not need to be clipped.
- The microcontroller notch indicates how the IC should be mounted into the socket after the socket has been soldered into the PCB.

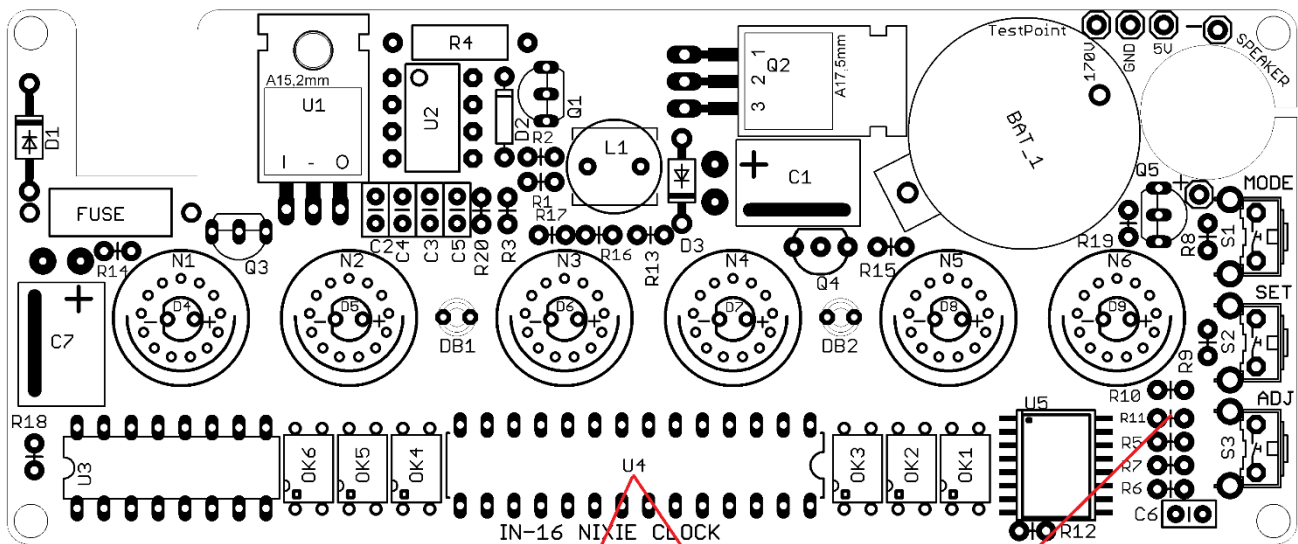

5.1. Take the resistor R11 and bend it, like pointed in item 3.1. Insert resistor into the board holes marked as R11 and solder it leads.

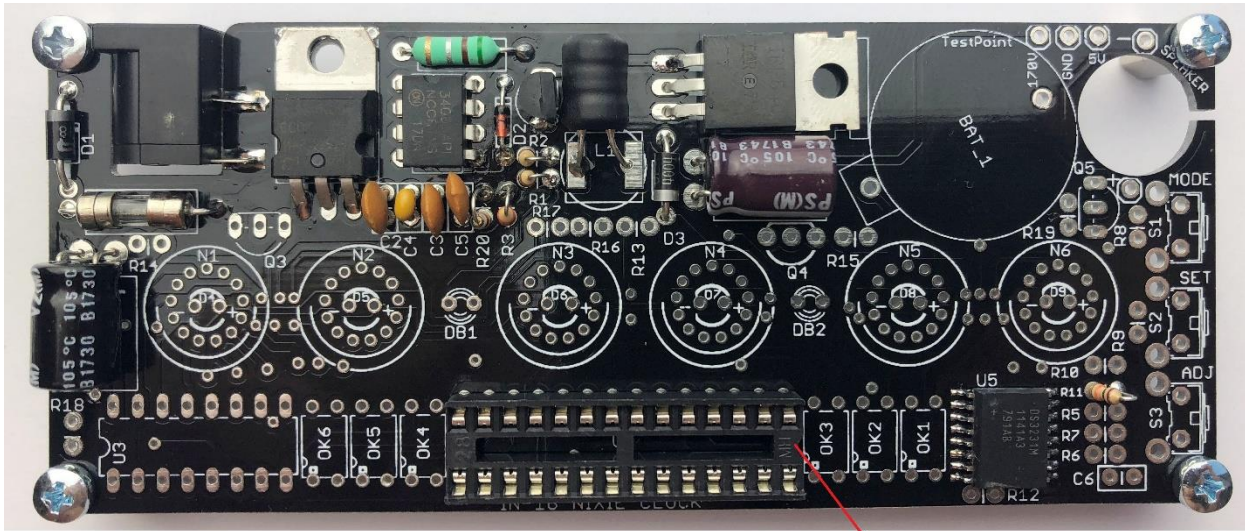

NOTCH

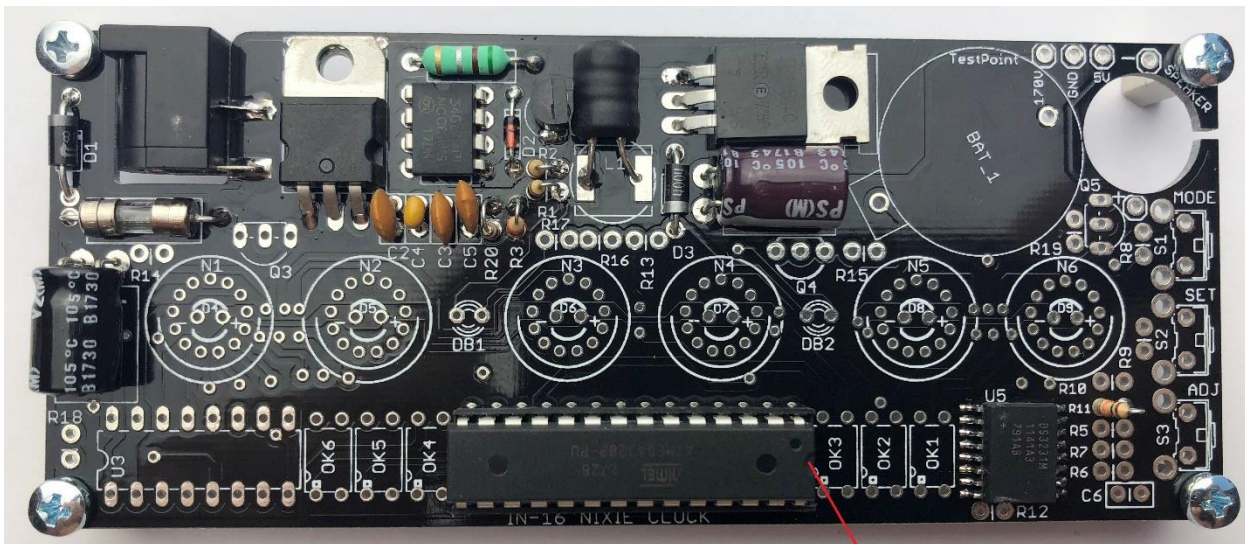

NOTCH

6. Tube driver circuit components

U3	K155ИД1
OK1-OK6	EL817
R12	330Ω
U3 socket	16 pin socket

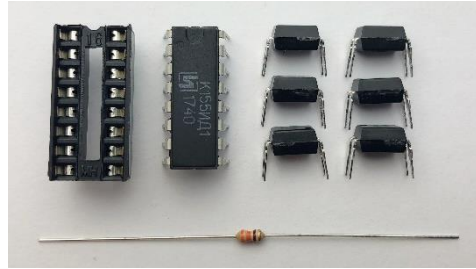

6.1. Take the resistor R12 and bend it, like pointed in item 3.1. Insert resistor into the board holes marked as R12 and solder it leads.

6.2. Actions for tube driver IC and its socket mounting are similar as pointed in item 5. Check your work results with picture below.

6.3. One end of the OK1 ... OK6 symbol on the PCB has a half-hole at one end of the symbol. In optocouplers OK1 ... OK6 first pin of the case marked by small dot. Install the optocouplers so that the end with the dot is at the end of the half-hole symbol on the PCB. Press the IC firmly into the holes into the PCB and solder the pins taking care not to create any solder "bridges" between the pins.

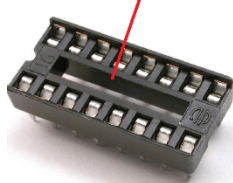
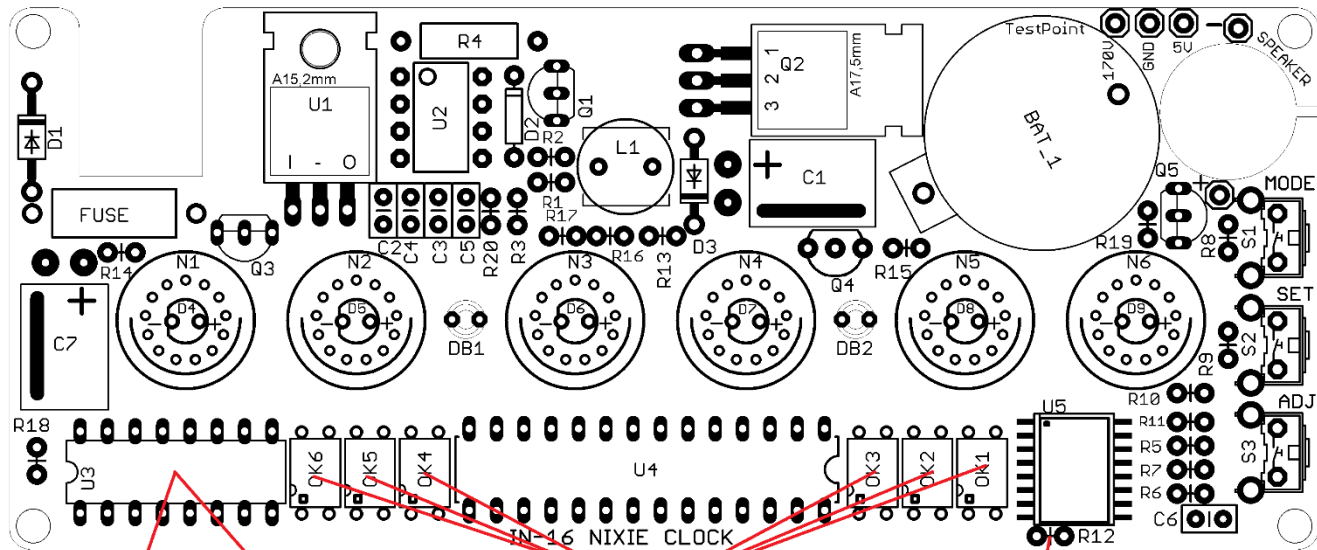

16Pin Socket

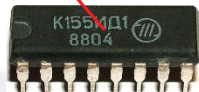

K155ИД1 (U3)

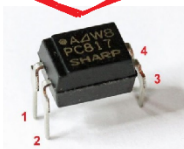

EL817 (OK1-OK6)

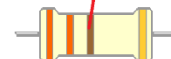

330Ω (R12)

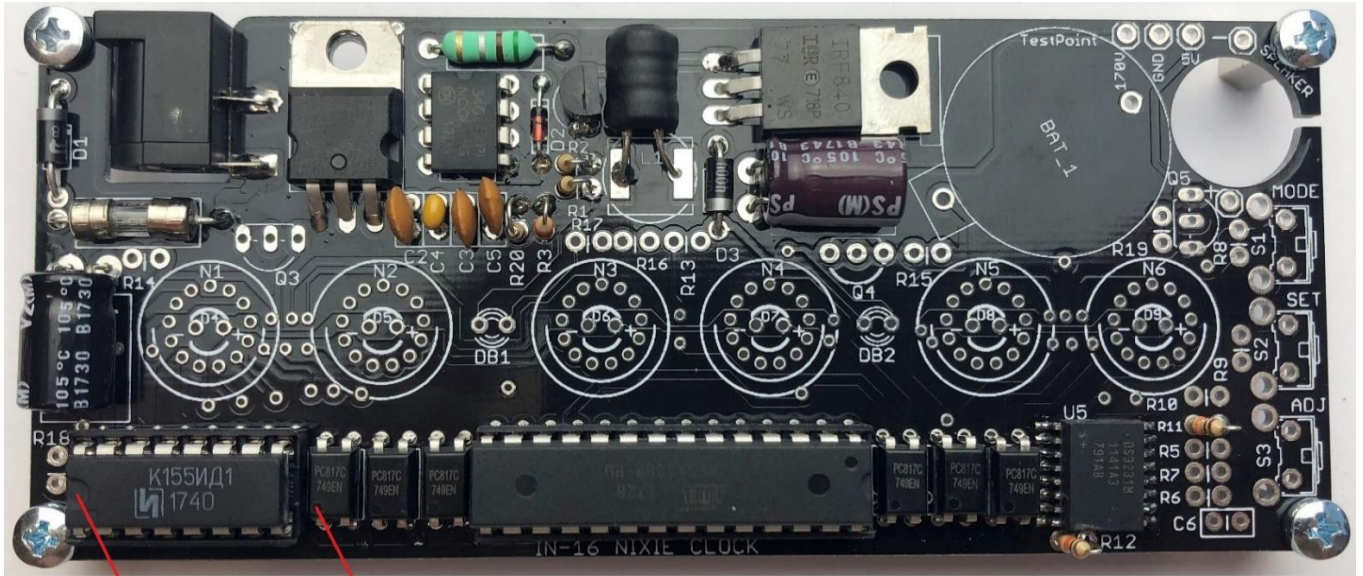

NOTCH FIRST PIN

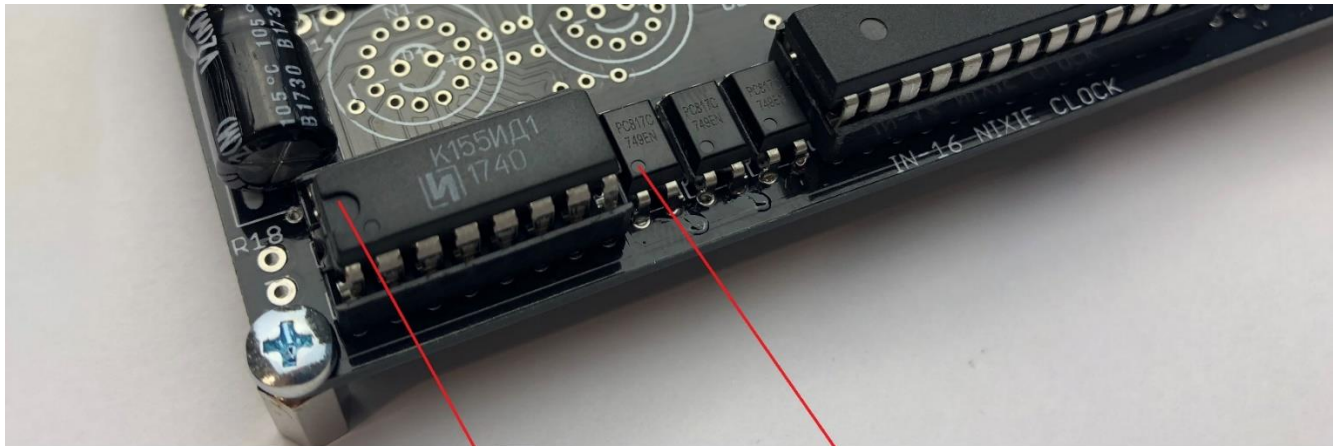

NOTCH FIRST PIN

7. RTC (real time clock) circuit components assembly

U5	DS3231
C6	0.1uF
R5, R6, R7	10kΩ
BAT_1	CR2032 Battery socket
Battery	3V CR2032



- 7.1. Take the resistors R5, R6, R7 and bend them, like pointed in item 3.1. Insert each resistor into the board holes marked as R5, R6 and R7 respectively and solder its leads.
- 7.2. Solder capacitor C6 on the board at location C6.
- 7.3. Battery has polarity (+/-) and requires special attention when mounting. Its socket BAT_1 solder as pointed on the picture. Insert the battery into the socket.

NOTE: An integrated circuit U5 DS3231 is in SMD (surface mount device) case, which is very difficult for soldering. Due to it soldered in advance.

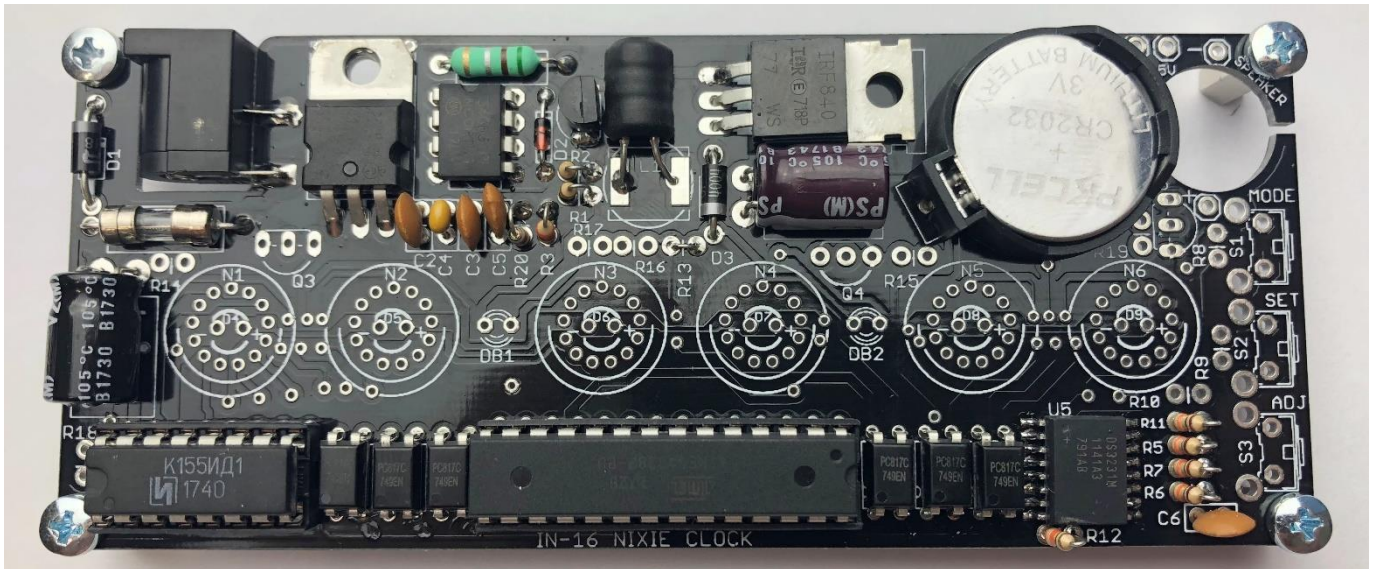
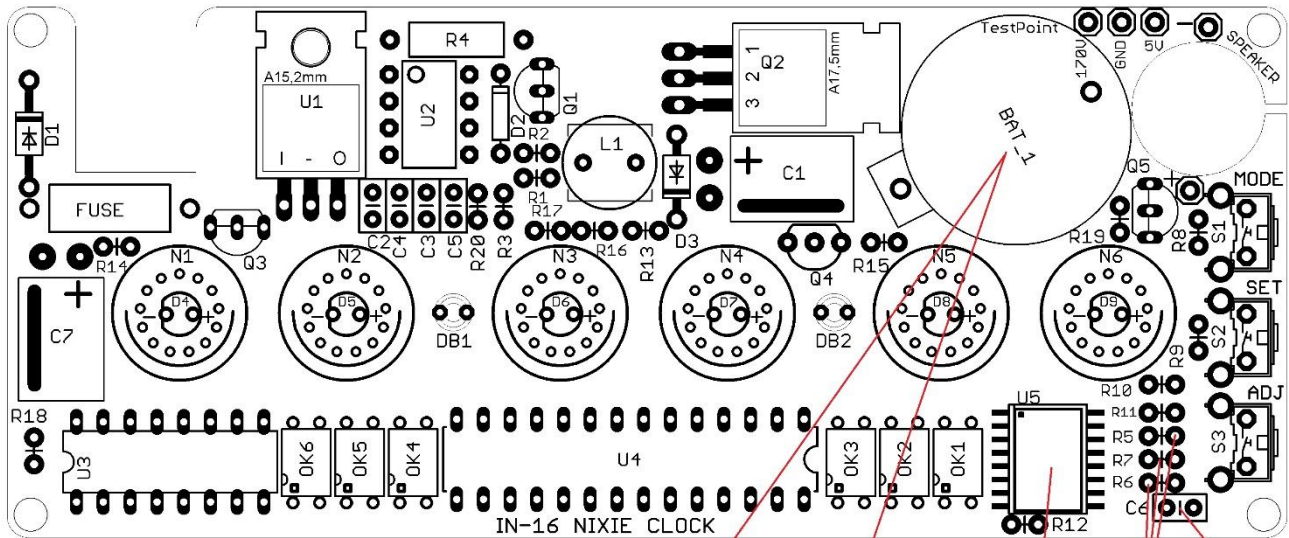

8. Buttons circuit components assembly

S1-S3	Buttons
R8, R9, R10	10kΩ

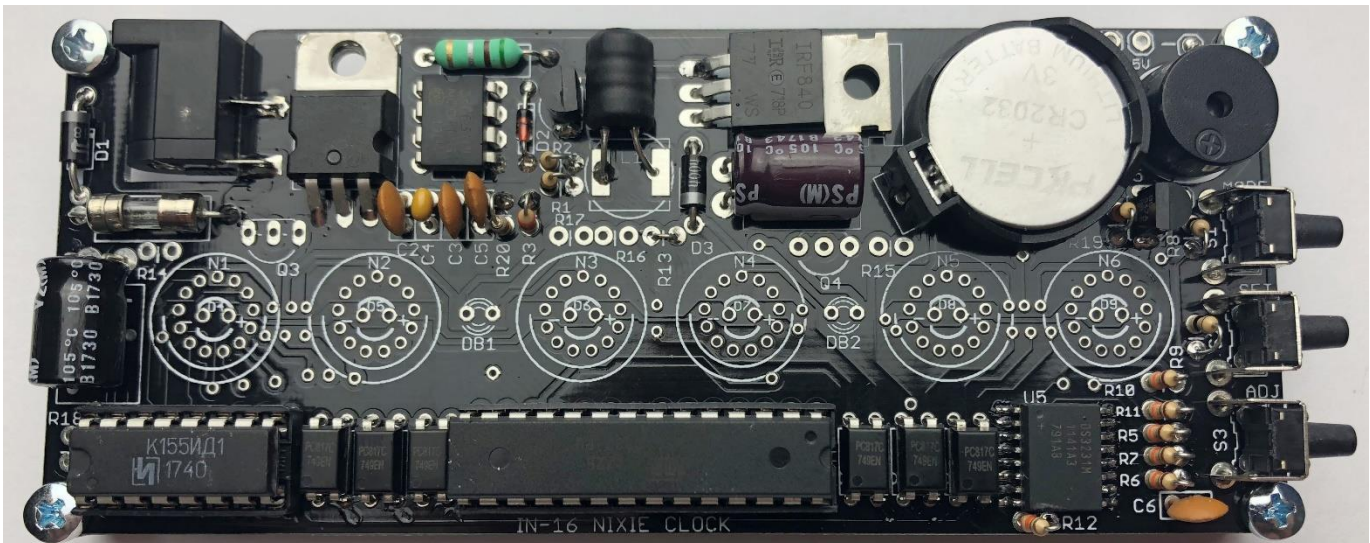
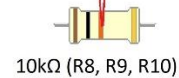
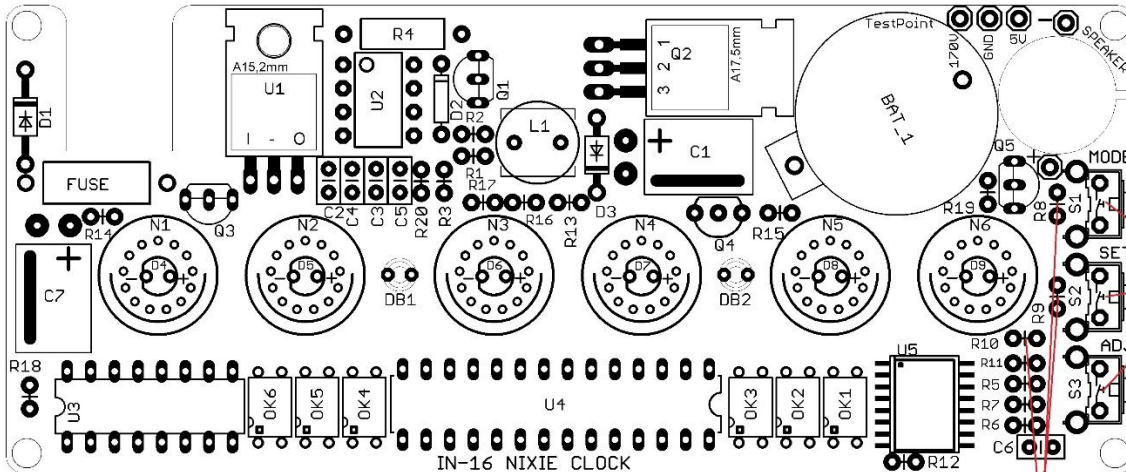
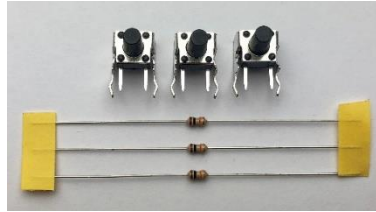

- 8.1. Parts S1-S3 are right-angle tactile button switches. Insert them into locations S1, S2 and S3, and make sure that they sit flat on the board. Solder all four pins of each switch.
- 8.2. All resistors R8, R9 and R10 leads bend in accordance with item 3.1. Insert them into locations R8, R9, R10 and solder their leads as pointed on the picture.

9. Speaker circuit components assembly

Q5	BC547
R19	10kΩ
Speaker	

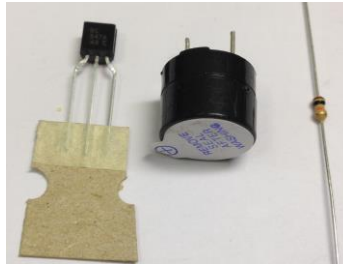

- 9.1. Take the resistor R19 and bend it, like pointed in item 3.1. Insert resistor into the board holes marked as R19 and solder it leads.
- 9.2. Install the transistor Q5 legs into the board holes marked as Q5 that its case flat edge is above the flat edge of the placement marking. Solder it leads.
- 9.3. Bend speaker leads. Speaker is polarized device and requires special attention when mounting. Install the lead marked (+) in the hole marked (+) and opposite lead in the hole marked (-). Solder leads from board opposite side as pointed on the picture.
- 9.4. Remove speaker seal after soldering.

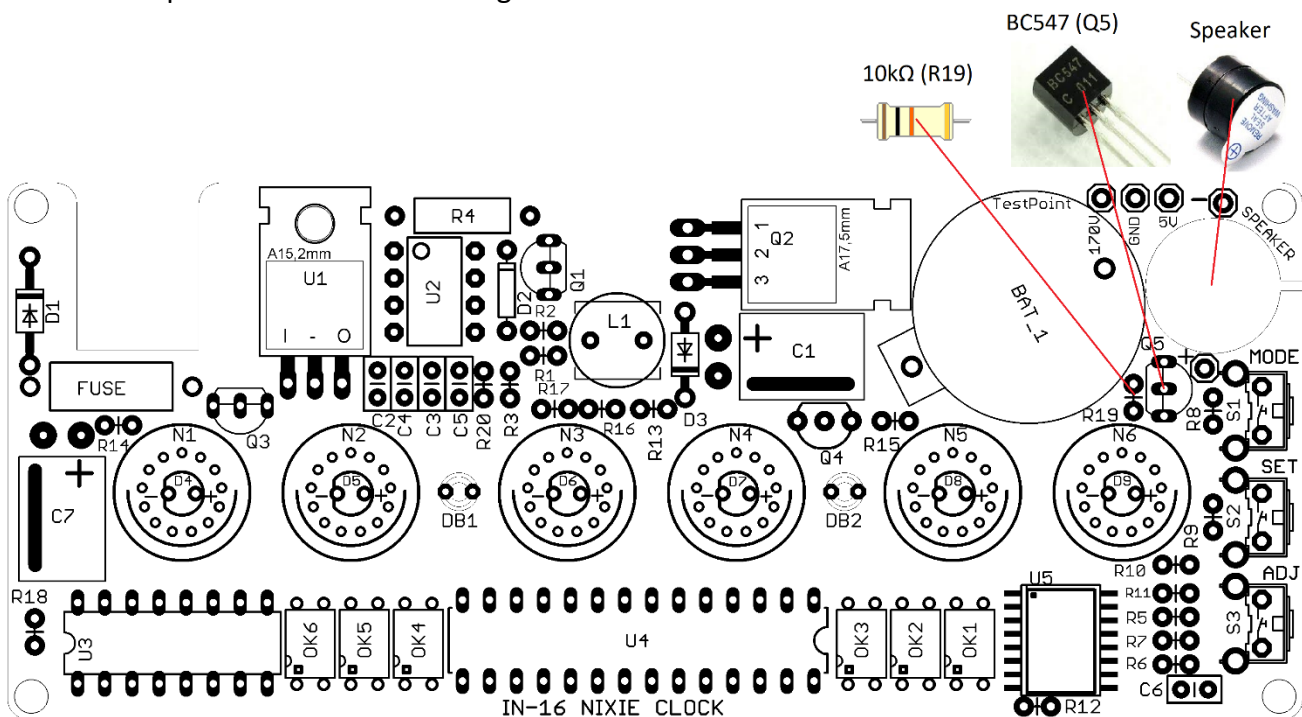

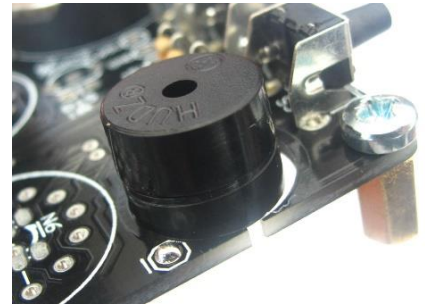
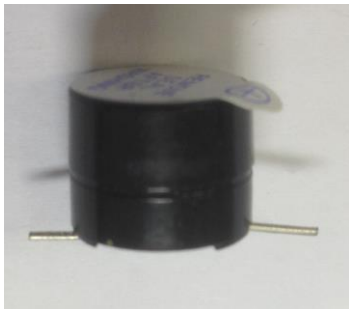
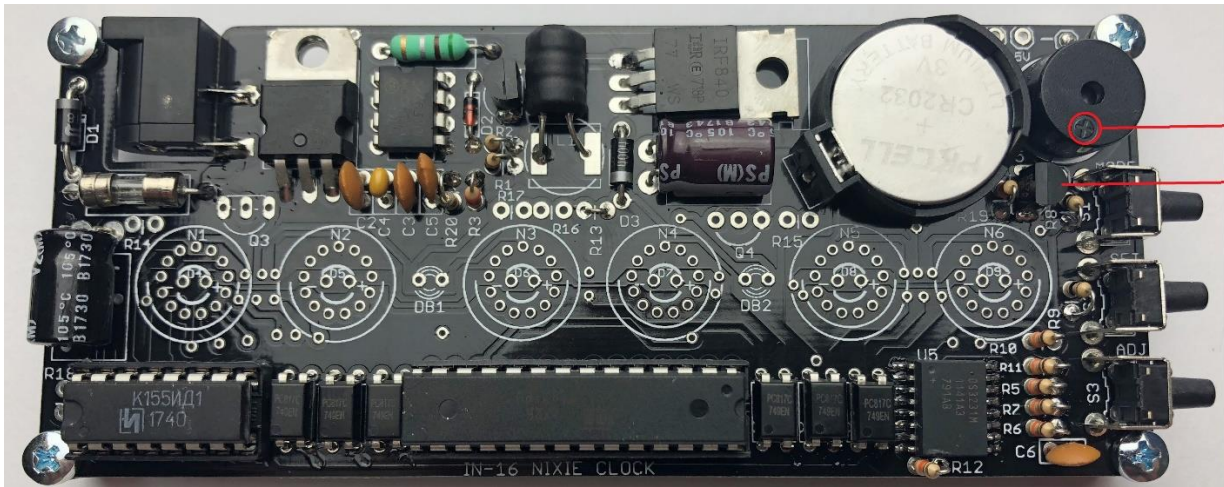

10. LED backlight circuit components

R18	10k Ω
R14	330 Ω
Q3	BC547
LED1-LED6	LED, 3mm

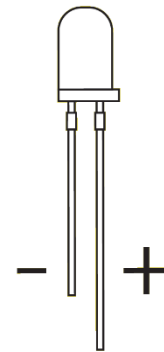
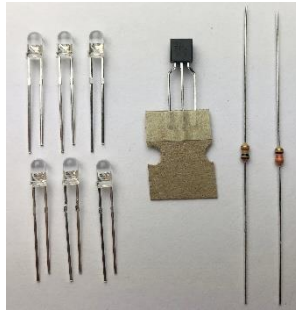

10.1. Resistor R14, R18 leads bend in accordance with item 3.1. Insert them into location R14, R18 and solder it's leads as pointed on the picture.

10.2. Install the transistor Q3 legs into the board holes marked as Q3 that its case flat edge is above the flat edge of the placement marking. Solder it leads.

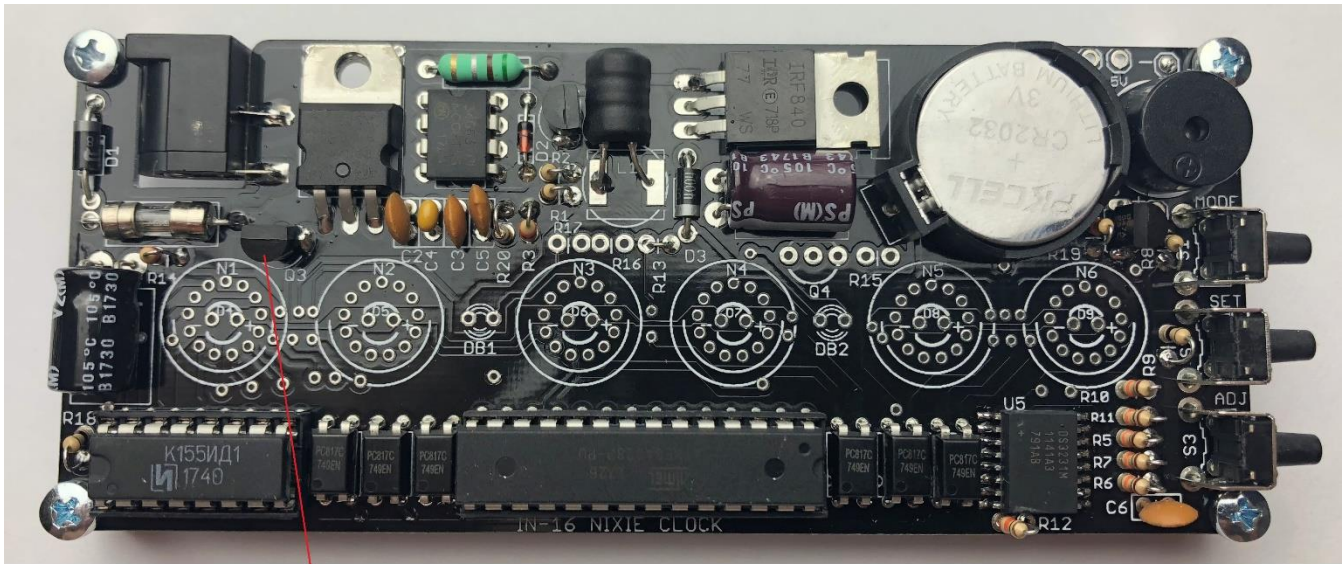
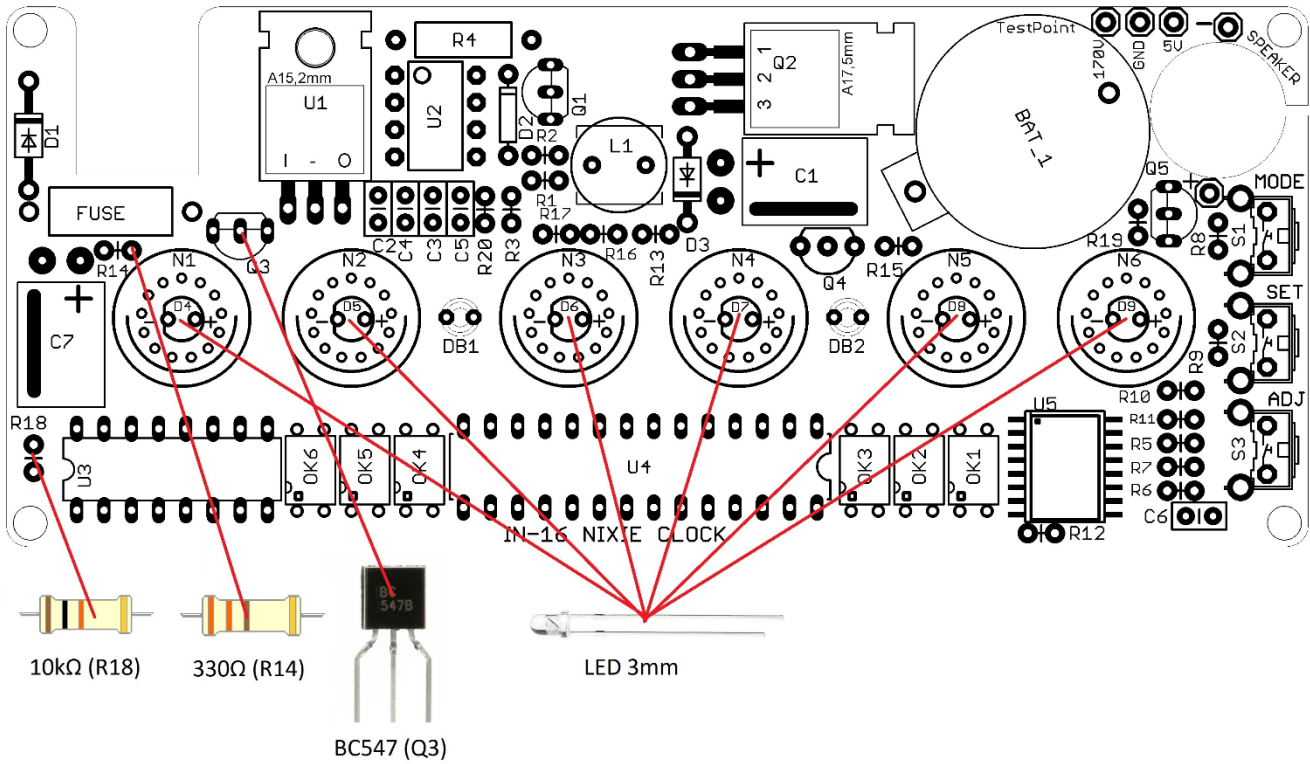

ROUNDING

10.3. Turn the PCB board to the other side and screw spacers.

10.4. Each LED (LED1 ... LED6) must be mounted pointing vertically upwards for the bottom side of the board so that the long lead (the anode "+") is inserted into the relevant hole marked (+). Be sure to mount LEDs properly because it is very difficult to de-solder them without damage if they mounted backward. Remember, LEDs are heat-sensitive also, so do not hold the soldering iron on the pad too long.

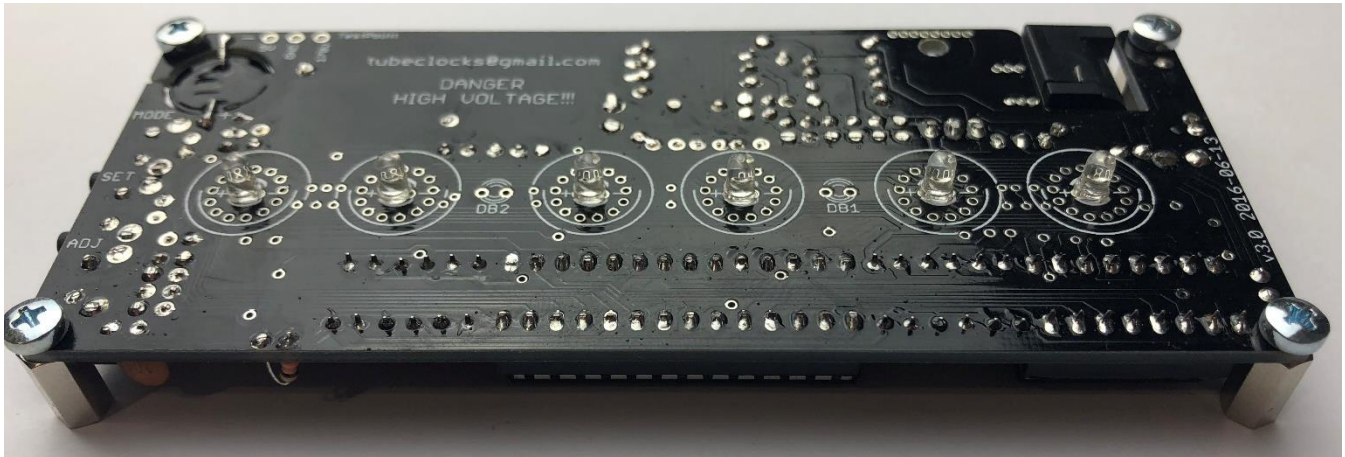

10.5. Plug in the power supply, and then check or all of the LEDs light up. If not, check all relevant joints quality and polarity. Do not continue with the assembly until the error will be corrected.

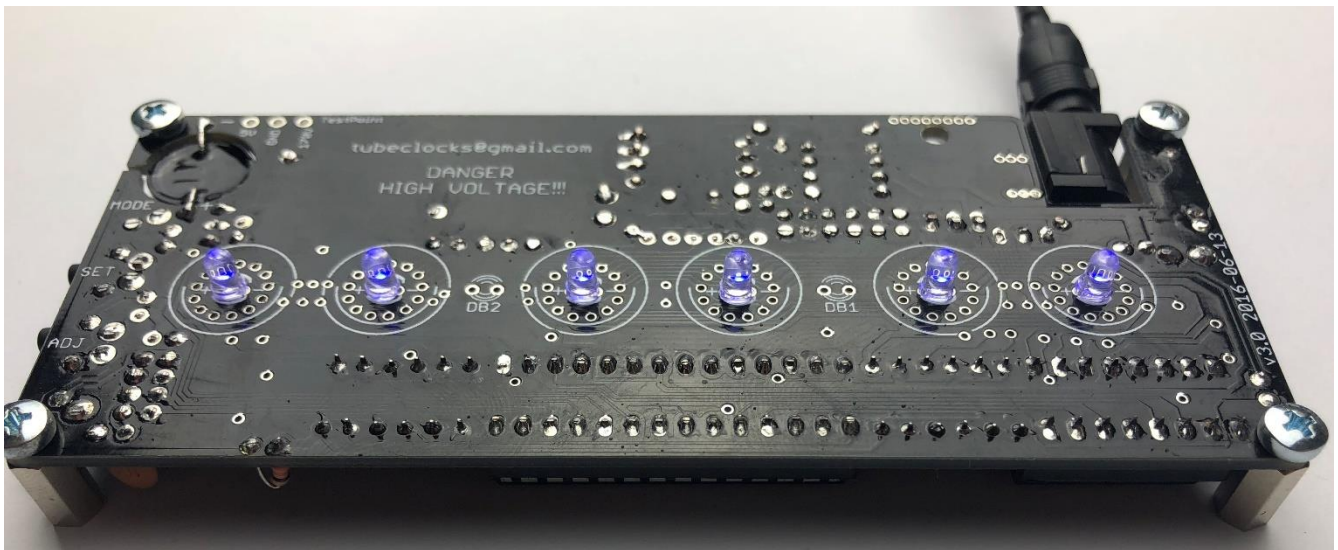

10.6. Disconnect power supply.

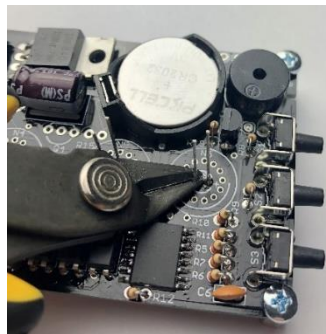
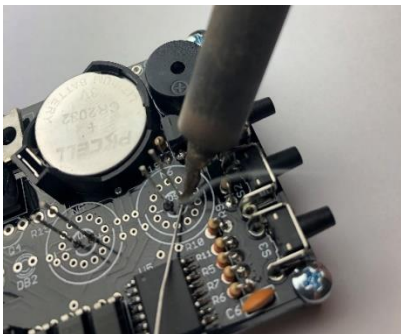

11. Neon dot circuit components

DB1, DB2	Neon Bulb
R16, R17	680k Ω
R15	10k Ω
Q4	MPSA42

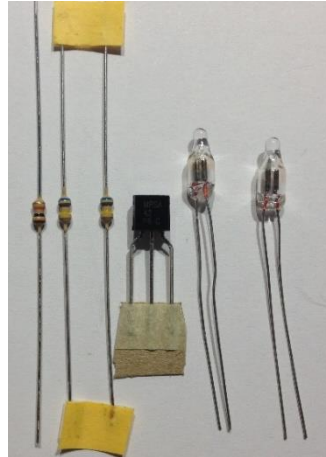

11.1. Resistors R15, R16 and R17 leads bend in accordance with item 3.1. Insert them into locations R15, R16, R17 and solder their leads as pointed on the picture.

11.2. Install the transistor Q4 legs into the board holes marked as Q4 that its case flat edge is above the flat edge of the placement marking. Solder it each leg in accordance with sub-item 10.2 directions.

NOTE: Neon bulbs DB1 and DB2 you must install later after nixie tubes soldering.

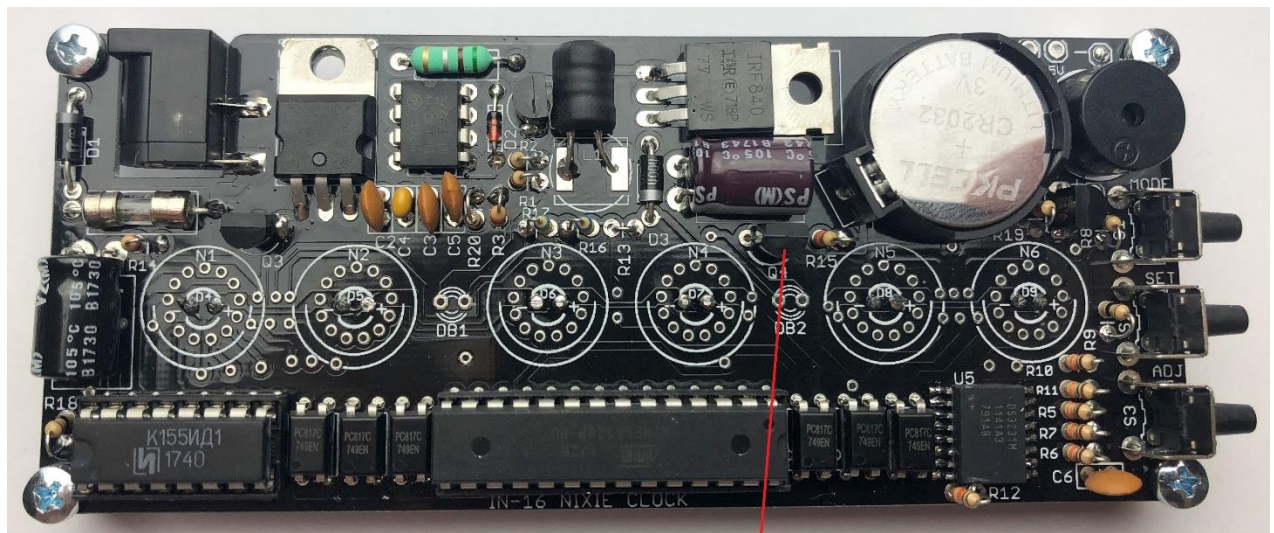
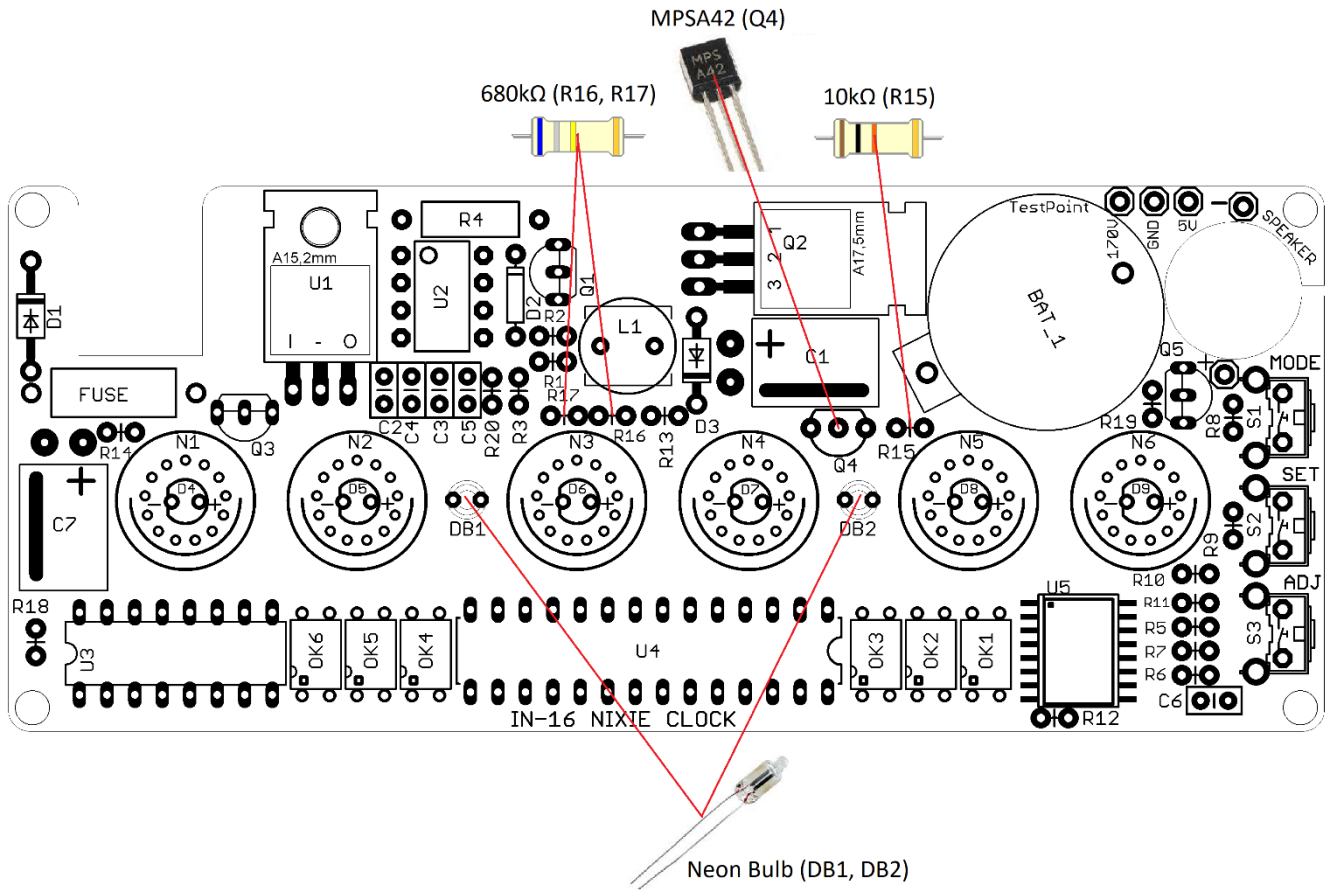

12. Nixie tube mounting order

Nixie tube mounting is most responsible work, because it is very difficult to de-solder its wires without PCB damage if they mounted incorrectly. You must follow our step-by-step assembly instructions. For clock six pcs IN-16 nixie tubes are necessary.



12.1. For each tube cut wires until ~ 15 mm length. Remove a plastic holder. By using long nose pliers, smooth out an each tube wire.



12.2. Screw the spacers on the other side of the PCB.

12.3. One by one begin to install tubes into the PCB relevant placement holes. Lead marked by white bar is anode. You must insert it into the hole of placement marked by [N1 ... N6].

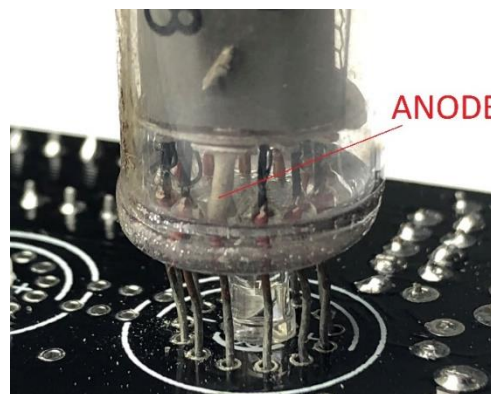
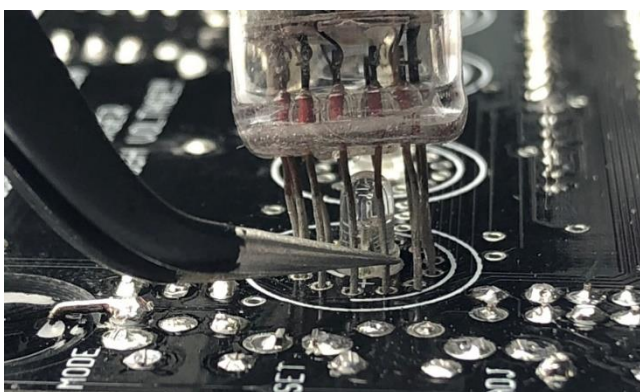
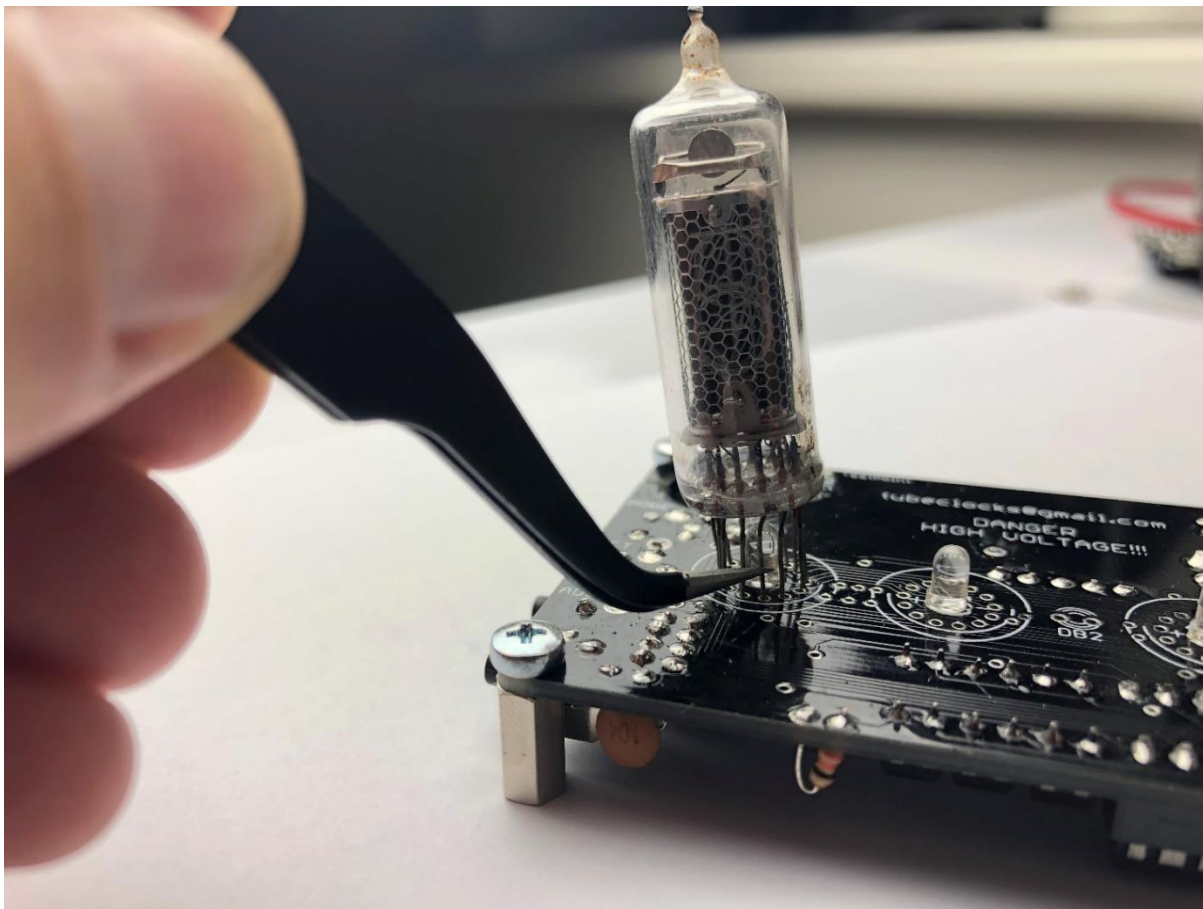

12.4. Install all tubes on the same height. Level tubes that they stand straight. After inserting a tube leads into the board, solder its two opposite leads first. This will hold the tube in place. Look at it

carefully to check it proper height and reciprocal arrangement. It is important that tubes will not inclined to the sides. If not, it is easy to heat one or both leads and adjust the relevant tube. Only if everythis correct, solder the rest leads from opposite PCB side.

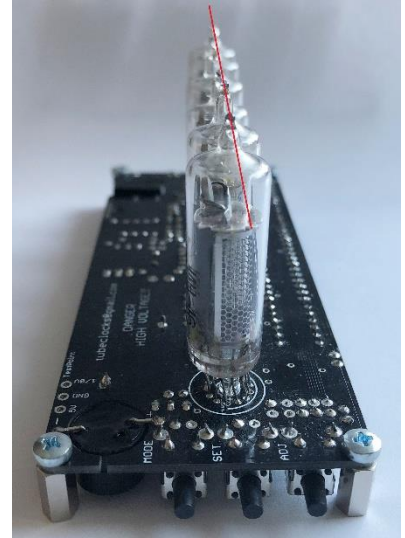
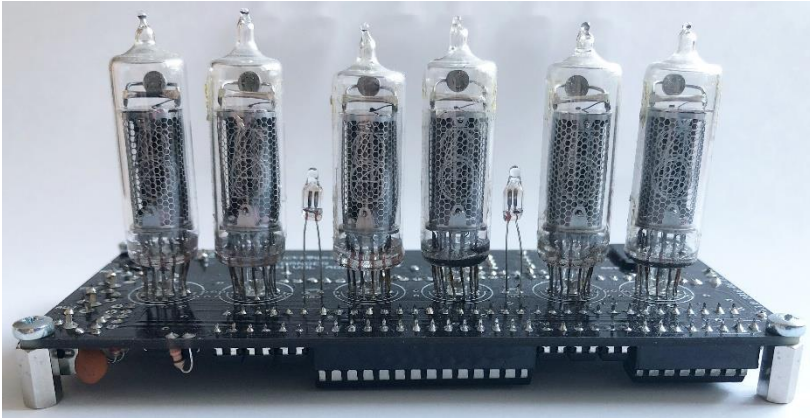

12.5. To solder Neon bulbs DB1 and DB2 in place on the PCB.

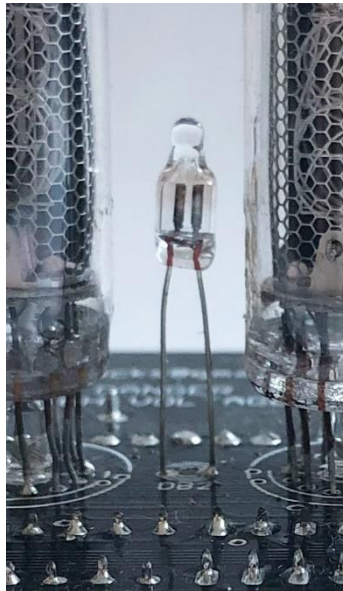

12.6. Cut the excess leads short (as close as possible to the PC board).

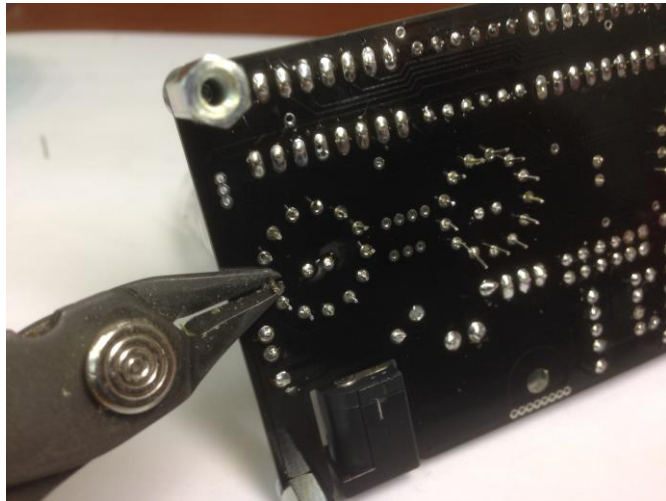

12.7. Plug in the power DC 12V supply. If all components installed and soldered properly the clock shall begin to operate.



13. PCB dimensions

PCB dimensions pointed on the drawing below. They will be necessary if you decide to make the case for clock. All dimensions pointed in millimetres. Highest electronics component height is equal 9 mm.

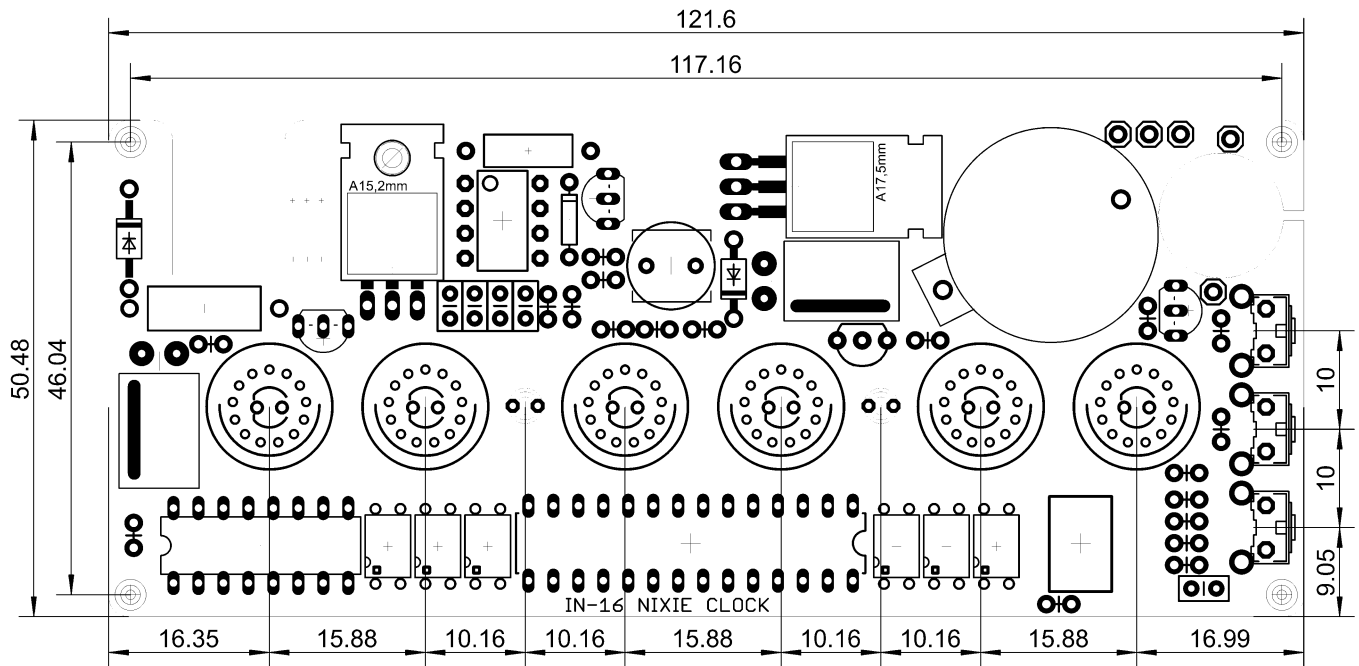

14. Clock configuration and operation

The three buttons of the clock have the following functions:

Button 1 - Mode, Button 2 - Set, Button 3 - Adjust

- Press Button 1 (Mode) to choose mode number
- Press Button 2 (Set) to reach mode settings menu
- Press Button 3 (Adjust) to increase value
- Press Button 2 (Set) to confirm chosen value
- Press Button 1 (Mode) to return to main time display.

NOTE: Longer hold a pressed button the selected value automatically increases.

The clock has 14 configuration modes:

- Mode 1: Alarm settings (0 - disable; 1 - enable)
- Mode 2: Set alarm time HH/MM. Alarm settings supports only 24-hour mode
- Mode 3: Set time HH/MM/SS. Time can be set only in 24-hour mode. Time can be displayed in either 12 or 24 - mode
- Mode 4: Set date DD/MM/YY
- Mode 5: 24 or 12-hours mode (0 – Set 24-hour mode; 1 – Set 12-hour mode). 12-hour mode AM/PM indication displayed on neon colon indicators. AM – neon indicators not blinking, PM – indicators blinking at 1Hz
- Mode 6: Date format (0 – DD/MM/YY; 1 – MM/DD/YY)
- Mode 7: BLUE Led brightness (LED Brightness from 0 to 10)
- Mode 8: Leading zero blanking (0 – disable; 1 – enable)
- Mode 9: Tube effect (0 – disabled, 1 – crossfade, 2 – each tube refresh)
- Mode 10: Slot Machine frequency (0 – every 5min; 1 – every 10min; 2 – every 15min; 3 – every 20min)
- Mode 11: Night mode (0 – disable; 1 – enable)
- Mode 12: Night mode On time (Set the time when the tubes should turn OFF)
- Mode 13: Night mode OFF time (Set the time when the tubes should turn ON)
- Mode 14: Reset settings to default (0 – current settings, 1 – reset)

During Clock Operation, the following Hot Buttons are used:

- Button 2: Short press to display date for 3 sec
- Button 3: Short press to OFF alarm when is active.
- When night mode is active, press any of the buttons to turn on the clock for 5 seconds